

# **SmartLine Wireless Transmitter**

## **Professional Installation Guide**

**34-SW-25-03**

**Revision 2**

**December 2019**

---

# Notices and Trademarks

**Copyright 2019 by Honeywell International Inc.  
Revision 2, December 2019**

While this information is presented in good faith and believed to be accurate, Honeywell disclaims the implied warranties of merchantability and fitness for a particular purpose and makes no express warranties except as may be stated in its written agreement with and for its customers.

In no event is Honeywell liable to anyone for any indirect, special or consequential damages. The information and specifications in this document are subject to change without notice.

Honeywell, PlantScape, Experion PKS, and **TotalPlant** are registered trademarks of Honeywell International Inc.

Other brand or product names are trademarks of their respective owners.

**Honeywell Process Solutions**  
**1250 W Sam Houston Pkwy S**  
**Houston, TX 77042**

---

## About This Document

This document outlines professional installation requirements for the SmartLine™ Wireless Pressure Transmitter

for the Honeywell OneWireless Network. Professional installation is required to comply with certification

agency and legal requirements. This document must be adhered to for all installations of the Honeywell SmartLine Wireless Transmitters.

Honeywell does not recommend using devices for critical control where there is a single point of failure or where single points of failure result in unsafe conditions. OneWireless is targeted at open loop control, supervisory control, and controls that do not have environmental or safety consequences. As with any process control solution, the end-user must weigh the risks and benefits to determine if the products used are the right match for the application based on security, safety, and performance. Additionally, it is up to the end-user to ensure that the control strategy sheds to a safe operating condition if any crucial segment of the control solution fails.

### Revision Information

Document Name	Document ID	Publication Date
SmartLine Wireless Transmitter Professional Installation Guide	<b>34-SW-25-03</b> Revision Number	
1 <sup>st</sup> release	Revision 1	December 2018
Refs to wireless temperature transmitter models added	Revision 2	December 2019

### References

The following list identifies all documents that may be sources of reference for material discussed in this publication.

Document Title	Doc #
SmartLine Wireless Pressure Transmitter User's manual	34-SW-25-01
SmartLine Wireless Temperature Transmitter User's manual	34-SW-25-04
OneWireless R310 Release Notes	OWDOC-X252-en-310A
OneWireless R310 Migration Users Guide	OWDOC-X258-en-310
OneWireless R310 Field Device Access Point Users Guide	OWDOC-X256-en-310
OneWireless R310 Wireless Device Manager Users Guide	OWDOC-X254-en-310
OneWireless R300 Experion PKS Integration Guide	OWDOC-X259-en-300
OneWireless R300 Wireless LAN Controller Configuration Guide	OWDOC-X255-en-300
OneWireless R300 Network Planning an Installation Guide	OWDOC-X253-en-300

---

## Support and contact info

For Europe, Asia Pacific, North and South America contact details, refer to the back page of this manual or the appropriate Honeywell Support web site:

Honeywell Corporate [www.honeywell.com](http://www.honeywell.com)

Honeywell Process Solutions <https://www.honeywellprocess.com/>\*











Training Classes <https://www.honeywellprocess.com/en-US/training>

## Telephone and Email Contacts





Area	Organization	Phone Number
United States and Canada	Honeywell Inc.	1-800-343-0228 Customer Service
		1-800-423-9883 Global Technical Support
Global Email Support	Honeywell Process Solutions	<a href="mailto:hfs-tac-support@honeywell.com">hfs-tac-support@honeywell.com</a>

## Symbol Definitions

The following table lists those symbols used in this document to denote certain conditions.

Symbol	Definition
	<b>ATTENTION:</b> Identifies information that requires special consideration.
	<b>TIP:</b> Identifies advice or hints for the user, often in terms of performing a task.
<b>CAUTION</b>	Indicates a situation which, if not avoided, may result in equipment or work (data) on the system being damaged or lost, or may result in the inability to properly operate the process.
	<b>CAUTION:</b> Indicates a potentially hazardous situation which, if not avoided, may result in minor or moderate injury. It may also be used to alert against unsafe practices. <b>CAUTION</b> symbol on the equipment refers the user to the product manual for additional information. The symbol appears next to required information in the manual.
	<b>WARNING:</b> Indicates a potentially hazardous situation, which, if not avoided, could result in serious injury or death. <b>WARNING</b> symbol on the equipment refers the user to the product manual for additional information. The symbol appears next to required information in the manual.
	<b>WARNING, Risk of electrical shock:</b> Potential shock hazard where HAZARDOUS LIVE voltages greater than 30 Vrms, 42.4 Vpeak, or 60 VDC may be accessible.
	<b>ESD HAZARD:</b> Danger of an electro-static discharge to which equipment may be sensitive. Observe precautions for handling electrostatic sensitive devices.
	<b>Protective Earth (PE) terminal:</b> Provided for connection of the protective earth (green or green/yellow) supply system conductor.
	<b>Functional earth terminal:</b> Used for non-safety purposes such as noise immunity improvement. NOTE: This connection shall be bonded to Protective Earth at the source of supply in accordance with national local electrical code requirements.
	<b>Earth Ground: Functional earth connection.</b> NOTE: This connection shall be bonded to Protective Earth at the source of supply in accordance with national and local electrical code requirements.
	<b>Chassis Ground:</b> Identifies a connection to the chassis or frame of the equipment shall be bonded to Protective Earth at the source of supply in accordance with national and local electrical code requirements.

continued

Symbol	Description
	<p>The Factory Mutual® Approval mark means the equipment has been rigorously tested and certified to be reliable.</p>
	<p>The Canadian Standards mark means the equipment has been tested and meets applicable standards for safety and/or performance.</p>
	<p>The Ex mark means the equipment complies with the requirements of the European standards that are harmonized with the 94/9/EC Directive (ATEX Directive, named after the French "ATmosphere EXplosible").</p>
	<p>For radio equipment used in the European Union in accordance with the R&amp;TTE Directive the CE Mark and the notified body (NB) identification number is used when the NB is involved in the conformity assessment procedure. The alert sign must be used when a restriction on use (output power limit by a country at certain frequencies) applies to the equipment and must follow the CE marking.</p>

	<p>The ISA100 Wireless Compliant logo indicates the device has received ISA100.11a conformance certification and is registered with the Wireless Compliance Institute, assuring device interoperability.</p>
<p>CRN</p>	<p>Canadian Registration Number</p>

# Contents

<b>1.</b>	<b>DESIGNATION, SCOPE AND PREFACE .....</b>	<b>1</b>
1.1	Designation.....	1
1.2	Scope.....	2
1.3	Preface .....	2
1.4	Site survey .....	2
1.5	Abbreviations & Definitions .....	3
<b>2.</b>	<b>FEDERAL COMMUNICATION COMMISSION (FCC) .....</b>	<b>5</b>
2.1	FCC Compliance Statement .....	5
2.2	Industry Canada (IC) .....	5
2.2.1	IC Compliance Statements.....	5
2.2.2	RF Safety Statement .....	5
2.3	FCC and Industry Canada (IC) Identification Numbers .....	6
2.3.1	ISA100 Radios.....	6
2.4	Intended Country Usage.....	6
2.4.1	NORTH AMERICA .....	6
2.4.2	EUROPEAN UNION .....	6
<b>3.</b>	<b>SMARTLINE WIRELESS TRANSMITTER GENERAL DESCRIPTION .....</b>	<b>7</b>
3.1	Intended Used.....	7
3.2	SmartLine Wireless Transmitter .....	7
<b>4.</b>	<b>PRODUCT SPECIFICATION .....</b>	<b>8</b>
4.1	ISA100 Radio, 2.4 GHz .....	8
4.2	SmartLine Wireless Transmitter User Environment.....	9
4.3	SmartLine Wireless Instrument Power Specifications.....	9
4.4	Weight .....	9
4.5	Dimensions .....	10
<b>5.</b>	<b>CABLES.....</b>	<b>11</b>
5.1	SmartLine Wireless Transmitter with N Connectors Antenna or Lightning Arrestor Cables.....	11
5.2	Transmitter connection status.....	11
5.3	Antenna Lightning Arrestors .....	12

- 6. APPROVED ANTENNA TYPES/GAINS ..... 13**
  - 6.1 Antenna Details.....13
- 7. EQUIVALENT ISOTROPICALLY RADIATED POWER (EIRP) ..... 14**
  - 7.1 EIRP LIMITS.....14
- 8. SETTING TX POWER ..... 18**
  - 8.1 TX Power Setting .....18
- 9. AGENCY LABEL INFORMATION..... 19**
  - 9.1 External FCC/IC Labels .....19
    - 9.1.1 External FCC/IC Label..... 19
- 10. RF SAFETY, MAXIMUM PERMISSIBLE EXPOSURE (MPE) STATEMENT..... 20**
  - 10.1 MPE Statement .....20
- 11. AGENCY COMPLIANCE..... 21**
  - 11.1 Radio and EMC Certifications.....21
    - 11.1.1 Federal Communication Commission (FCC) ..... 21
    - 11.1.2 Industry Canada (IC) ..... 21
    - 11.1.3 European Telecommunications Standards Institute (ETSI) ..... 21
  - 11.2 Product Safety Agency Certifications.....21
    - 11.2.1 European Union Certification (CE-mark) ..... 21



## Tables

Table 1-1 – SmartLine Wireless Transmitter Types .....	1
Table 1-2 –Table of Abbreviations and Definitions.....	3
Table 4-1 Specifications of ISA100 Radio Module in SmartLine Wireless Transmitter.....	8
Table 4-2 User Environment Specifications for SmartLine Wireless Transmitter .....	9
Table 5-1 Transmitter to Antenna or Lightning Arrestor Cable Specifications for SmartLine Wireless with N connectors .....	11
Table 6-1 Approved Antenna Types/Gains .....	13
Table 7-1 Maximum EIRP Limits for ISA100 Radios.....	14
Table 7-2 ISA100 Transmit Power Settings for the antennas and cable lengths specified above.....	16

## Figures

Figure 3-1 SmartLine Wireless Pressure Transmitter showing 4 dBi Integral Antenna .....	7
Figure 4-1 Dimensions of a typical SmartLine Wireless Transmitter with the 4 dBi Integral Antenna Option .....	10
Figure 6-1 Remote Antennas.....	13



# 1. Designation, Scope and Preface

## 1.1 Designation

This document is valid for the following SmartLine Wireless Transmitter types:

**Table 1-1 – SmartLine Wireless Transmitter Types**

<b>Model Number Type</b>	<b>Model Number Description</b>	<b>Model Key Number</b>
STDW	Differential Pressure Transmitter	STDW810/820/830/870/720/730/770
STGW	Gauge Pressure Transmitter	STGW840/870/84L/87L STGW740/770/73L/74L/77L/78L/79L
STAW	Absolute Pressure Transmitter	STAW84L/740/74L
STFW	Flange Mount Pressure Transmitter	STFW828/724
STRW	Remote Seal Pressure Transmitter	STRW87G/74G/82D/73D
STIW	Temperature Transmitter	STIW400
STUW	Universal I/O Transmitter	STUW750/751

## 1.2 Scope

This document outlines professional installation requirements for the Honeywell SmartLine Wireless Transmitter for the Honeywell OneWireless Network. Professional installation is required to comply with certification agency and legal requirements. This document must be adhered to for all installations of the Honeywell OneWireless SmartLine Wireless Transmitters.

## 1.3 Preface

This manual covers professional installation of the Honeywell OneWireless SmartLine Wireless Transmitters. See the Getting Started with Honeywell OneWireless, Honeywell OneWireless Planning Guide and Honeywell OneWireless SmartLine Wireless User's Guides for general information on overall system implementation, configuration, and management of these devices.

The SmartLine Wireless is classified by the FCC as a device that must be professionally installed. To be in compliance with FCC requirements, the transmitter must be installed with one of the approved antennas listed in this document.

## 1.4 Site survey

It is assumed for the purposes of this document that a site survey has been performed and that the antenna types, cable lengths and lightning surge arrestors were appropriately selected per the results of that survey. Any changes to these items as a result of the actual installation of the SmartLine Wireless transmitters into the site may require that the TX power setting of the radio board needs to be adjusted from the factory setting in order to maintain agency approvals. See [Section 7](#) and [Section 8](#) for more information.

## 1.5 Abbreviations & Definitions

The term **Honeywell SmartLine Wireless Transmitter** will be used to describe the composite unit which includes the Honeywell ISA100 RF Module and all subassemblies housed within the SmartLine Wireless Transmitter enclosure.

**Table 1-2 –Table of Abbreviations and Definitions**

ACMA	Australian Communications and Media Authority
AD	Authentication Device
ANATEL	National Telecommunications Agency (Agência Nacional de Telecomunicações)
ATEX	Potentially Explosive Atmospheres Directive
AWG	American Wire Gauge
Co-located	Two or more radios transmitting simultaneously and with less than 20cm of separation distance.
CSA	Canadian Standards Association
DCS	Distributed Control System
DSSS	Direct Sequence Spread Spectrum
EMC	Electromagnetic Compatibility
ETSI	European Telecommunications Standards Institute
EU	European Union
FCC	Federal Communications Committee
FHSS	Frequency-Hopping Spread Spectrum
FM	Factory Mutual
FSK	Frequency Shift Keying
GFSK	Gaussian Frequency Shift Keying
GTS	Honeywell Global Technical Services
IC	Industry Canada
IEEE	Institute of Electrical and Electronics Engineers
INMETRO	National institute of Metrologia, Quality and Technology (Instituto Nacional de Metrologia, Qualidade e Tecnologia)
IR	Infrared
IrDA	Infrared Data Association
ISA100	International Society of Automation open-standard wireless networking technology
KCC	Korean Communications Commission, Republic of Korea

KMOC	Kuwait Ministry of Communications
MIC	Japan Ministry of Internal Affairs and Communications
MPE	Maximum Permissible Exposure
MSG	Honeywell Model Selection Guide
NA	North America – United States of America and Canada
NEMA	National Electrical Manufacturers Association
OQPSK	Offset Quadrature Phase-Shift Keying
TELEC	Japan Telecom Engineering Center
TIIS	Japan Technology Institution of Industrial Safety
TNTC	Thailand National Telecommunications Commission
TX	Transmit
Wi-Fi	Wireless Local Area Network based on IEEE 802.11 Specifications
WNSIA	Wireless Network for Secure Industrial Application

## 2. Federal Communication Commission (FCC)

### 2.1 FCC Compliance Statement

- This device complies with Part 15 of FCC Rules and Regulations. Operation is subject to the following two conditions: (1) This device may not cause harmful interference and (2) this device must accept any interference received, including interference that may cause undesired operation.
- This equipment has been tested and found to comply with the limits for a Class A digital device, pursuant to Part 15 of the FCC Rules. These limits are designed to provide reasonable protection against harmful interference in a residential installation. This equipment generates, uses, and can radiate radiofrequency energy and, if not installed and used in accordance with these instructions, may cause harmful interference to radio communications. Operation of this equipment in a residential area is likely to cause harmful interference in which case the user will be required to correct the interference at his own expense.
- Intentional or unintentional changes or modifications must not be made to the SmartLine Wireless unless under the express consent of the party responsible for compliance. Any such modifications could void the user's authority to operate the equipment and will void the manufacturer's warranty.

### 2.2 Industry Canada (IC)

#### 2.2.1 IC Compliance Statements

- To reduce potential radio interference to other users, the antenna type and its gain should be so chosen that the equivalent isotropic radiated power (EIRP) is not more than that permitted for successful communication.
- Operation is subject to the following two conditions: (1) this device may not cause interference, and (2) this device must accept any interference, including interference that may cause undesired operation of the device.
- This Class A digital apparatus complies with Canadian ICES-003.
- French: Cet appareil numérique de la classe A est conforme à la norme NMB-003 du Canada.

#### 2.2.2 RF Safety Statement

- To comply with FCC's and Industry Canada's RF exposure requirements, the following antenna installation and device operating configurations must be satisfied.
- Remote Point-to-Multi-Point antenna(s) for this unit must be fixed and mounted on outdoor permanent structures with a separation distance between the antenna(s) of greater than 20 cm and a separation distance of at least 20 cm from all persons.
- Furthermore, when using integral antenna(s) the SmartLine Wireless unit must not be co-located with any other antenna or transmitter device and have a separation distance of at least 20cm from all persons.

## 2.3 FCC and Industry Canada (IC) Identification Numbers

This information is shown on the product.

### 2.3.1 ISA100 Radios

- Honeywell Identification for ISA100 Intrinsically Safe RF Modules: 51454941-001
- Honeywell SmartLine Wireless Transmitter ISA100 Radio Limited Modular Approval
- Federal Communication Commission Identification for Intrinsically Safe RF Modules: S5751454941
- Industry Canada Identification for Intrinsically Safe RF Modules: 573W-51454941

## 2.4 Intended Country Usage

### 2.4.1 NORTH AMERICA

Country	ISO 3166 2 letter code
Canada	CA
United States	US

### 2.4.2 EUROPEAN UNION

Region	2 letter code
European Union	EU



## 3. SmartLine Wireless Transmitter General Description

### 3.1 Intended Used

The SmartLine Wireless Transmitter is a key component of the Honeywell OneWireless Network. The SmartLine Wireless Transmitter uses a low-powered ISA100 2.4 GHz radio to communicate with Radio Infrastructure and Gateway devices that are connected to a wired DCS network.

### 3.2 SmartLine Wireless Transmitter

Figure 3-1 shows the SmartLine Wireless Transmitter with integral antenna.



**Figure 3-1** SmartLine Wireless Pressure Transmitter showing 4 dBi Integral Antenna

## 4. Product Specification

### 4.1 ISA100 Radio, 2.4 GHz



#### **WARNING!**

- The SmartLine Wireless Transmitter must be Professionally Installed in accordance with the requirements specified in this document. See Section 7 for professional installation maximum TX power setting requirements. Only the specified TX power settings, antenna types and gains and cable lengths (attenuation) as outlined in this document are valid for SmartLine Wireless Transmitter installations.

**Table 4-1 Specifications of ISA100 Radio Module in SmartLine Wireless Transmitter**

Item	Specification
Wireless Standard	FCC 15.247 / IEEE 802.15.4 Direct Sequence Spread Spectrum (DSSS), 2.4 GHz
Data Rates and Modulation	Data Rate: 250 kbps Modulation: Offset Quadrature Phase-Shift Keying (OQPSK – DSSS)
Frequency Band	2,405 – 2,475 MHz
Module Transmit Power	Maximum: 20 dBm (Maximum transmit power will vary by channel)
Receive Sensitivity (typical)	-100 dBm

## 4.2 SmartLine Wireless Transmitter User Environment

**Table 4-2 User Environment Specifications for SmartLine Wireless Transmitter**

Item	Specification
Operating Temperature:	-40°C to +85°C (-40°F to +185°F)
Storage Temperature:	-40°C to +85°C (-40°F to +185°F)
Operating Humidity:	0 to 100% RH

Other Environmental specifications and information may be found in the appropriate Instrument Specification available on the Honeywell website. [www.honeywellprocess.com](http://www.honeywellprocess.com)

## 4.3 SmartLine Wireless Instrument Power Specifications

The SmartLine Wireless Transmitters operate from two (2) D-size 3.6V Lithium Thionyl Chloride (Li/SOCl<sub>2</sub>) batteries. These are joined in series to produce a maximum voltage of +7.6 Vdc. An optional external +24 Volt power supply option is also available.

## 4.4 Weight

Most non-pressure sensing versions of the SmartLine Wireless transmitter have a maximum weight of 7.0 lbs (3.2 kg). Pressure transmitter versions can weigh from 7.0 lbs (3.2 kg) to 35 lbs (15.9 kg) for a flange equipped model. These weights do not include remote cables or antennas. Add 8.0 lbs (3.6 kg) to any transmitter equipped with the stainless steel housing option (A3 or SH option).

### 4.5 Dimensions

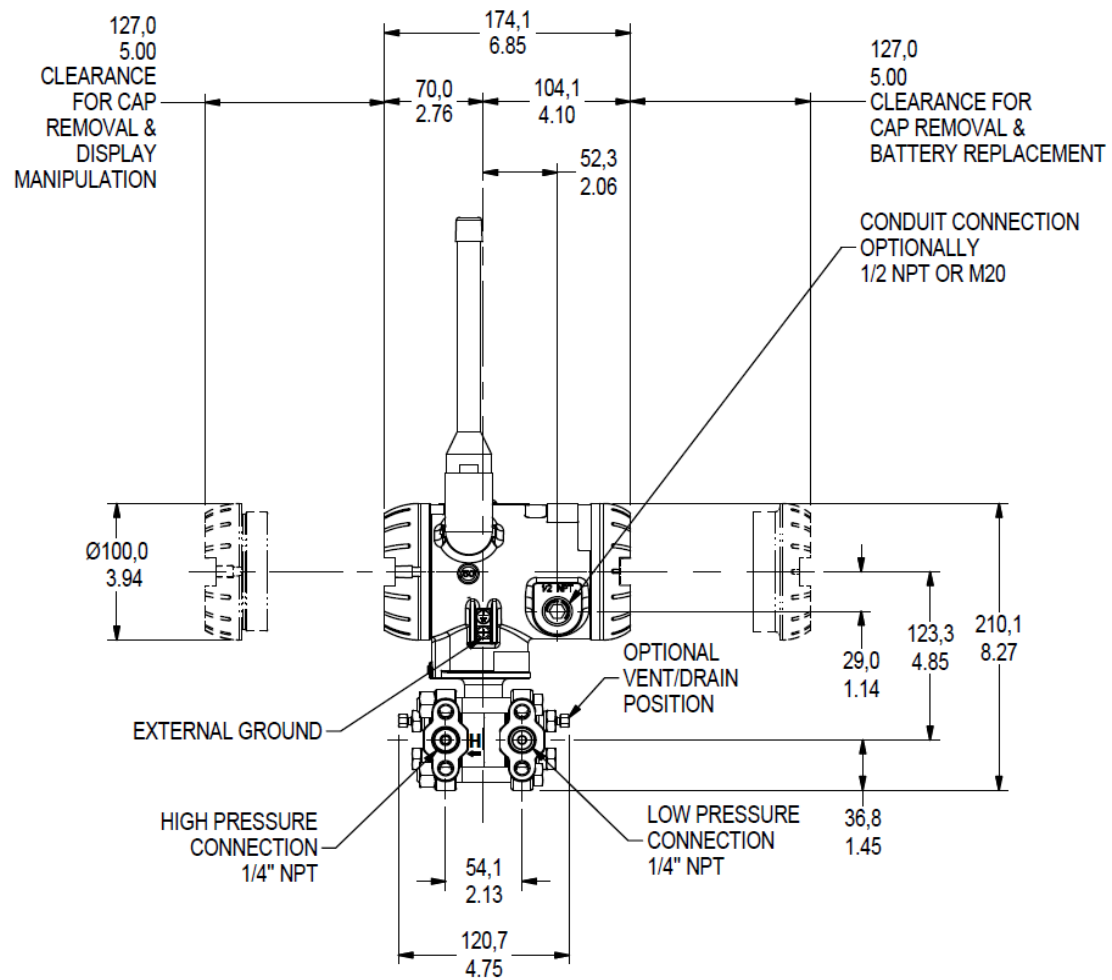

Figure 4-1 Dimensions of a typical SmartLine Wireless Transmitter with the 4 dBi Integral Antenna Option

## 5. Cables

### 5.1 SmartLine Wireless Transmitter with N Connectors Antenna or Lightning Arrestor Cables

**Table 5-1 Transmitter to Antenna or Lightning Arrestor Cable Specifications for SmartLine Wireless with N connectors**

Honeywell Part Number	Cable Type	Connector Type	Frequency (GHz)	Length (m)	Loss (dB)
50018278-001	400 Series	N male to N male	2.4	1	1
50018278-003	400 Series	N male to N male	2.4	3	2
50018278-010	400 Series	N male to N male	2.4	10	3

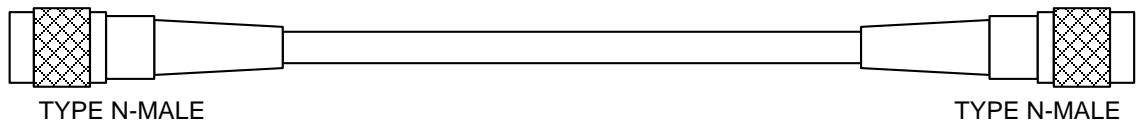

### 5.2 Transmitter connection status

**Table 5-3 Lightning Arrestor to Antenna Cable Specifications**

Honeywell Part Number	Cable Type	Connector Type	Frequency (GHz)	Length (m)	Loss (dB)
50018278-001	400 Series	N male to N male	2.4	1	1
50018278-003	400 Series	N male to N male	2.4	3	2
50018278-010	400 Series	N male to N male	2.4	10	3

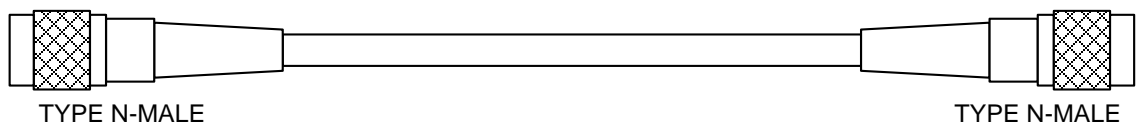

### 5.3 Antenna Lightning Arrestors

**Table 5-4 Lightning Arrestor Specifications for Remote Antenna(s)**

Honeywell Part Number	Manufacturer	Manufacturer Part Number	Specification	Connector Type	Frequency (GHz)	Attenuation (dB)
50018279-090	ALTELECON	AL-NFNFB-9	50 ohm	N Female to N Female	0 – 3	0.4 (max)

The lightning surge arrester must be properly grounded in order to perform per specification. Connecting to local ground using a No. 12 (4 mm<sup>2</sup>) copper conductor is recommended. See the installation manual for other details.



**Figure 5-1 Lightning Surge Arrester (Altelicon AL-NFNFB-9) 50018279-090**

## 6. Approved Antenna Types/Gains

### 6.1 Antenna Details

**Table 6-1 Approved Antenna Types/Gains**

Antenna Type	Antenna Application	Manufacturer	Manufacturer Part Number	Honeywell Part Number	Agency Compliance Notes
Omni (integral)	Point to Multi-Point	EM Wave	EM-B145103-MMP-Z6	50029933-002	
Omni (remote)	Point to Multi-Point	L-COM	HGV-2409U	50018414-001	
Directional (remote)	Point to Multi-Point	L-COM	HG2414D	50018415-001	

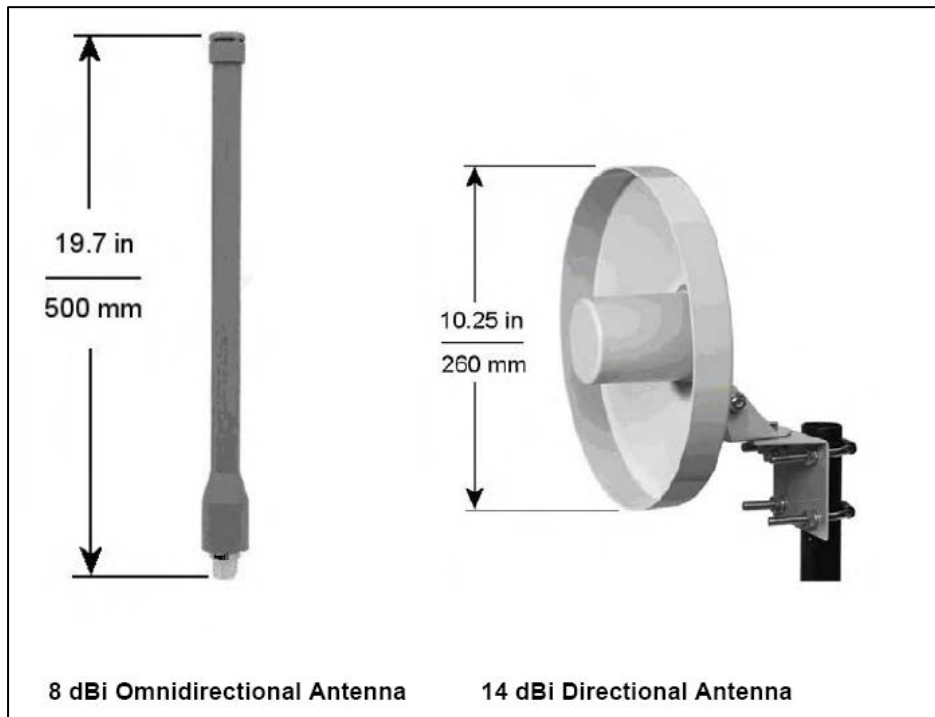

**Figure 6-1 Remote Antennas**

The SmartLine Wireless Transmitter is available with 8 dBi Omnidirectional or 14 dBi Directional Remote Antennas for all locations.

## 7. Equivalent Isotropically Radiated Power (EIRP)

In radio communication systems, Equivalent Isotropically Radiated Power (EIRP) or, alternatively, Effective Isotropic Radiated Power, is the amount of power that would have to be emitted by an isotropic antenna (that evenly distributes power in all directions and is a theoretical construct) to produce the peak power density observed in the direction of maximum antenna gain. EIRP can take into account the losses in transmission line and connectors and includes the gain of the antenna. The EIRP is often stated in terms of decibels over a reference power level that would be the power emitted by an isotropic radiator with an equivalent signal strength. The EIRP allows making comparisons between different emitters regardless of type, size or form. From the EIRP, and with knowledge of a real antenna's gain, it is possible to calculate real power and field strength values.

$$\text{EIRP(dBm)} = \text{Radio TX Power (dBm)} - \text{Cable Loss (dB)} + \text{Antenna Gain (dBi)}$$

Antenna gain is expressed relative to a (theoretical) isotropic reference antenna (dBi).

### 7.1 EIRP LIMITS

Table 7-1 Maximum EIRP Limits for ISA100 Radios

Antenna Type	Radio Usage / Application		Freq. (GHz)	Max. Ant. Gain (dBi)	Min. Cable Length (m)	Min. Cable Loss (dB)	Agency/Country	Max. TX Power Setting (dBm) <sup>1</sup>	Max. EIRP (dBm)
4 dBi Omni	Point to Multi-Point	Integral	2.4	4	0	0	FCC, IC, ACMA, ANATEL	16	20
							Japan	10	14
							ETSI, TNTC, KCC	12	16
							KOC 2485-2499 MHz	20	24
8 dBi Omni	Point to Multi-Point	Remote	2.4	8	1	1	FCC, IC, ACMA	12	20
							Japan	7	15
							ETSI, TNTC, KCC	8	16
							KOC 2485-2499 MHz	19	26
14 dBi Directional	Point to Multi-Point	Remote	2.4	14	1	1	FCC, IC, ACMA	6	20
							Japan	10	24
							ETSI, TNTC, KCC	2	16
							KOC 2485-2499 MHz	13	26
14 dBi Sectional	Point to Multi-Point	Remote	2.4	14	1	1	Japan	10	19.9



**Notes for Table 7-1:**

1. The Maximum TX Power Setting values given in [Table 7-1](#) represent the power produced by the Radio circuit within the RF Module. These Maximum TX Power Setting values do not include antenna gain nor do they include the losses caused by cables and connectors. When these external gains and losses are included, then using these Maximum TX Power Setting values ensures that the SmartLine Wireless EIRP will not exceed the maximum EIRP limits that are given in [Table 7-1](#).
2. The values in the above tables have been determined through agency certification testing.
3. The following shall apply for antenna type, frequency range, application/usage and agency/country compliance:
  - Antenna gains above the maximum values shown shall not be used.
  - Cable length/loss below the minimum values shown shall not be used.
  - Maximum overall radio output power shown shall not be exceeded.
  - Maximum EIRP values shown above shall not be exceeded.
4. **Industry Canada Compliance Statement:** This device has been designed to operate with the antenna types listed in this document, and having a maximum gain of 14 dBi. Antenna types not included in this list or having a gain greater than 14 dBi are strictly prohibited for use with this device. The required antenna impedance is 50 ohms.

**Table 7-2 ISA100 Transmit Power Settings for the antennas and cable lengths specified**

Description	Model Selection Guide Table IV <sup>1</sup>	Remote Cable(s) Length <sup>2</sup> (m)	TX Power Setting for ETSI/ TNTC / KCC <sup>3</sup> (dBm)	TX Power Setting for FCC/ IC/ KOC/ ACMA/ ANATEL <sup>3, 8</sup> (dBm)	TX Power Setting for Japan <sup>3, 4</sup> (dBm)
4 dBi Integral Antenna	---R00	N/A	12	16	10
8 dBi Omni w/o suppressor	---M10 or ---M20	1, 3	8	12	7
8 dBi Omni w/o suppressor	---M30	10	10	14	9
8 dBi Omni with suppressor	---M11	1+1	8	12	7
8 dBi Omni with suppressor	---M12 or ---M22 or ---M23 or ---M21 or ---M32 or ---M33	1+3, 3+3, 3+10, 3+1, 10+3, 10+10	9	13	8
8 dBi Omni with suppressor	--M31	10+1	10	14	9
14 dBi directional w/o suppressor <sup>6</sup>	---D10 or ---D20	1,3	2	6	10
14 dBi directional w/o suppressor <sup>6</sup>	---D30	10	4	8	10
14 dBi directional with suppressor <sup>6</sup>	---D11	1+1	2	6	10
14 dBi directional with suppressor <sup>6</sup>	---D12 or ---D21 or ---D22	1+3, 3+1, 3+3	2	6	10
14 dBi directional with suppressor <sup>6</sup>	---D23 or ---D32	3+10, 10+3	4	8	10
14 dBi directional with suppressor <sup>6</sup>	---D33	10+10	6	10	10
No remote antenna or cables option <sup>7</sup>	---A00	N/A	0	0	10

**Notes for Table 7-2**

1. The Model Number of any instrument may be found on the identification name plate located on the outside of the SmartLine Wireless transmitter. The values in the **Cable(s) Length** column represent those customer selections from Table IV of the SmartLine Wireless Model Selection Guides.
2. In the **Cable(s) Length** column, entries of the form “X+X” indicate that there are two cables between the SmartLine Wireless and the remote antenna, with a lightning surge arrester used to connect the two cables together. Entries of the form “X” mean that there is a single cable and that no lightning surge arrester is used. For entries of the form “X+X”; the first value is the length of the cable between the instrument and the arrester while the second value is the length of the cable between the arrester and the remote antenna. All cables are 400 series types as specified in Section 5 and [Table 5-1](#).
3. TX Power is set by the Honeywell factory producing the SmartLine Wireless. The factory set value for TX power is determined by the customer’s model number selections in the Model Selection Guide Table III for antenna type, cables and the lightning suppressor along with the customer’s selection in Table V for Country Code and is consistent with the values shown in [Table 7-2](#). If the Country location, cable lengths, antenna type or the use of a lightning surge arrester are changed in the field away from the Model Number listed on the instrument’s nameplate, then the TX power setting should likewise be changed per the tables above to match the new Country/antenna/cable/arrestor selections.  
See [Section 8](#).
4. Note reserved for future Japan certification
5. The TX Power Setting values given in [Table 7-2](#) represent the power produced by the Radio circuit within the RF Module. These TX Power Setting values do not include antenna gain nor do they include the losses caused by cables, connectors and lightning arrestors. When these external gains and losses are included, then using the TX power values in [Table 7-2](#) ensures that the SmartLine Wireless EIRP will not exceed the maximum EIRP limits that are given in [Table 7-1](#)
6. The TX Power Setting values given in [Table 7-2](#) for the 14 dBi directional antenna are also used for the 14 dBi sectional antenna shown in [Table 6-1](#). This sectional antenna is only approved for use in Japan.
7. Units with Model Selection Guide Table IV selection ---A00 are shipped without cables or a remote antenna. The Professional Installer must set the TX power for these units according to the characteristics of the antenna and cables selected by the end user, guided by the information provided above. Only Omnidirectional antennas with gains less than or equal to 8 dBi and Directional antennas with gains equal to or less than 14 dBi may be used and still meet Agency restrictions. The TX values used must result in an EIRP value that does not exceed the maximum EIRP values given in [Table 7-1](#). Honeywell recommends that, regardless of the antenna and cables used, that TX power not be set higher than 16 dBm in order to maximize the battery life of the instrument.
8. Note reserved for future use

## 8. Setting TX Power

### 8.1 TX Power Setting



#### WARNING!

- The SmartLine Wireless Transmitter must be Professionally Installed in accordance with the requirements specified in this document. Only the specified power settings, antenna types and gains and cable lengths (attenuation) as outlined in this document are valid for SmartLine Wireless Transmitter installations.
- 

The SmartLine Wireless as shipped from the factory will have its TX Power value set according to its Model Number and this value is consistent with those values given in Table 7-2.

The TX Power setting may be changed via the Authentication Device or Provisioning Device when a special application (app) is installed. This app is considered to be Honeywell sensitive material and is made available only to the qualified Professional Installer. Due to radio approval body regulations, changing the TX Power setting is only available if the professional installer option has been explicitly enabled on your Authentication Device or Provisioning Device. If you do not have the professional installer option enabled and would like to do so, then please contact Honeywell Global Technical Services (GTS). A separate application, AuthDev Power Settings, is required to enable the "Write TX Power Level" option.

When this app is installed in the AD, the SmartLine Wireless TX power setting, normally a read-only parameter, becomes a read/write parameter.

The TX Power adjustment feature is provided for Professional Installers to adjust the SmartLine Wireless TX power to match a change in the selection of antenna and cables made at the installation site and still ensure that the EIRP does not exceed the regulatory limits.



#### WARNING!

- **Japan** does not allow the installer to change the TX Power setting. For this reason, the special AD app is not available for installations in Japan.
-

## 9. Agency Label Information

The following information shall be clearly and permanently labeled on the SmartLine Wireless Transmitter unit:

### 9.1 External FCC/IC Labels

#### 9.1.1 External FCC/IC Label

THIS DEVICE COMPLIES WITH PART 15 OF THE FCC RULES. OPERATION IS SUBJECT TO THE FOLLOWING TWO CONDITIONS: (1) THIS DEVICE MAY NOT CAUSE HARMFUL INTERFERENCE, AND (2) THIS DEVICE MUST ACCEPT ANY INTERFERENCE RECEIVED, INCLUDING INTERFERENCE THAT MAY CAUSE UNDESIRE OPERATION.

## **10. RF Safety, Maximum Permissible Exposure (MPE) Statement**

### **10.1 MPE Statement**

To comply with FCC's and Industry Canada's RF exposure requirements, the following antenna installation and device operating configurations must be satisfied:

Remote antenna(s) for this unit must be fixed and mounted on outdoor permanent structures with a separation distance between the antenna(s) of at least 20 cm and a separation distance of at least 20 cm from all persons.

When using integral antenna(s) the SmartLine Wireless Transmitter unit must not be co-located with any other antenna or transmitter device and have a separation distance of at least 20 cm from all persons.

## 11. Agency Compliance

### 11.1 Radio and EMC Certifications

#### 11.1.1 Federal Communication Commission (FCC)

- Specification: FCC Part 15.247 Subpart B for unintentional radiators
- Specification: FCC Part 15.247 Subpart C for intentional radiators

#### 11.1.2 Industry Canada (IC)

- RSS-247, Issue 2

#### 11.1.3 European Telecommunications Standards Institute (ETSI)

- Specification and Method: EN 300 328 V2.1.1
- EMC Product Standard: EN 61326-1 (2013)

### 11.2 Product Safety Agency Certifications

See product manual for list of agency certifications and standards available. See product nameplate for transmitter certification information.

#### 11.2.1 European Union Certification (CE-mark)

- Compliance with:
  - Radio Equipment Directive 2014/53/EU
    - Includes EMC requirements EN 61326-1 : 2013
  - ATEX Directive 2014/34/EU
  - Pressure Equipment Directive 2014/68/EU

## Sales and Service

For application assistance, current specifications, pricing, or name of the nearest Authorized Distributor, contact one of the offices below.

### ASIA PACIFIC

Honeywell Process Solutions,  
(TAC) [hfs-tac-support@honeywell.com](mailto:hfs-tac-support@honeywell.com)

#### Australia

Honeywell Limited  
Phone: +(61) 7-3846 1255  
FAX: +(61) 7-3840 6481  
Toll Free 1300-36-39-36  
Toll Free Fax:  
1300-36-04-70

#### China – PRC - Shanghai

Honeywell China Inc.  
Phone: (86-21) 5257-4568  
Fax: (86-21) 6237-2826

#### Singapore

Honeywell Pte Ltd.  
Phone: +(65) 6580 3278  
Fax: +(65) 6445-3033

#### South Korea

Honeywell Korea Co Ltd  
Phone: +(822) 799 6114  
Fax: +(822) 792 9015

### EMEA

Honeywell Process Solutions,  
Phone: + 80012026455 or  
+44 (0)1344 656000

Email: (Sales)

[FP-Sales-Apps@Honeywell.com](mailto:FP-Sales-Apps@Honeywell.com)

or

(TAC)

[hfs-tac-support@honeywell.com](mailto:hfs-tac-support@honeywell.com)

### Web

Knowledge Base search  
engine <http://bit.ly/2N5Vldi>

### AMERICA'S

Honeywell Process Solutions,  
Phone: (TAC) 1-800-423-9883 or 215/641-  
3610  
(Sales) 1-800-343-0228

Email: (Sales)

[FP-Sales-Apps@Honeywell.com](mailto:FP-Sales-Apps@Honeywell.com)

or

(TAC)

[hfs-tac-support@honeywell.com](mailto:hfs-tac-support@honeywell.com)

### Web

Knowledge Base search  
engine <http://bit.ly/2N5Vldi>

For more information  
To learn more about SmartLine Transmitters,  
visit [www.honeywellprocess.com](http://www.honeywellprocess.com)  
Or contact your Honeywell Account Manager

Process Solutions

#### Honeywell

1250 W Sam Houston Pkwy S  
Houston, USA, TX 77042

Honeywell Control Systems Ltd  
Honeywell House, Skimped Hill Lane  
Bracknell, England, RG12 1EB

Shanghai City Centre, 100 Jungi Road  
Shanghai, China 20061

[www.honeywellprocess.com](http://www.honeywellprocess.com)



## Honeywell

AUTHORIZED DISTRIBUTOR

### De Gidts & Feldman BV

### The Netherlands

### www.dgfg.nl



INSTRUMENTATION & FILTRATION

## Honeywell

34-SW-25-03, Rev.2

December 2019

©2019 Honeywell International Inc.