

Wireless Module (50047099-501) Instructions

Used with 900 Control Station

Models 900CS10-00 and 900CS15-00

Document Number: 51-52-33-167 Revision 3

Effective: 5/17/11

Supersedes: Revision 2, 5/17/10

Summary

The Control Station GSM option card allows the user to add GSM/GPRS cellular modem capability to their Control Station operator interface terminal. GSM/GPRS is the most prevalent cellular technology in today's markets. GPRS can be used for services such as Wireless Application Protocol (WAP) access, Short Message Service (SMS), and for Internet communication services such as email and World Wide Web access. The Control Station GSM modem option card is quad-band, allowing it to work in frequencies across Americas, Europe and Asia. US and Canada work in the 850/1900 MHz bands, while Europe, Middle East, Africa and most of Asia work in the 900/1800 MHz GSM/GPRS frequencies.

The Control Station GSM requires the addition of a SIM (Subscriber Identity Module) card, which is inserted into the holder prior to installation of the Control Station GSM card. The SIM card securely stores the service-subscriber key (IMSI) used to identify a subscriber, and is used to connect to the network to obtain an IP address from the provider.

Contents of package

Check that you received the following items.

- GSM Option Card assembly
- Power connector
- Three screws
- Antenna
- Option Card label with FCC information

Safety Summary



EXPLOSION HAZARD

Do not disconnect equipment unless power has been disconnected and the area is known to be non-hazardous.



EXPLOSION HAZARD

The area must be known to be non-hazardous before servicing / replacing the unit and before installing or removing I/O wiring and battery.



WARNING - EXPLOSION HAZARD

SUBSTITUTION OF COMPONENTS MAY IMPAIR SUITABILITY FOR CLASS I, DIVISION 2



CAUTION: Risk Of Danger:
Read complete instructions prior to installation and operation of the unit



CAUTION: Risk Of Electric shock

ATTENTION

Failure to follow these installation instructions could result in diminished performance and/or invalidate the UL approvals.

Approvals

UL Listed
CSA Certified
FM Approved

for use in Hazardous (Classified) locations – Class I, Division 2, Groups A, B, C and D

Installing the Control Station GSM Option Card

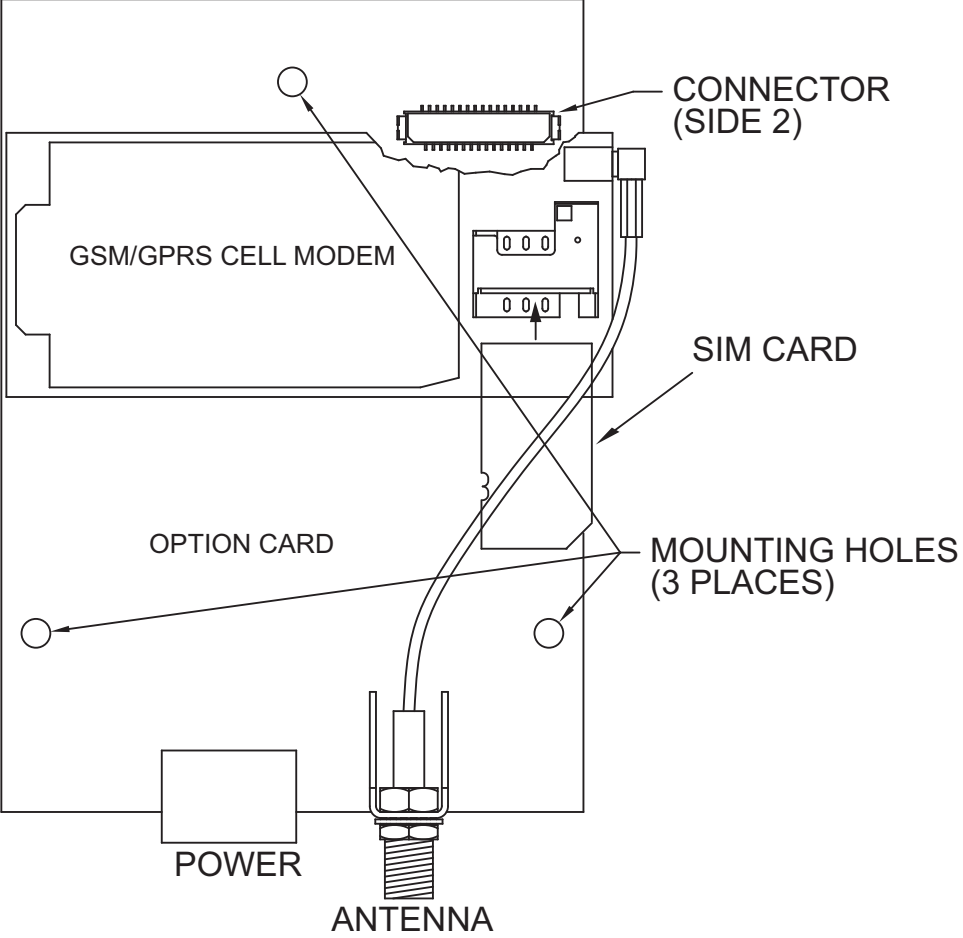
Step	Action
<p>⚠ WARNING</p>	<ul style="list-style-type: none"> The option and main circuit boards contain static sensitive components. Before handling the cards, discharge static charges from your body by touching a grounded bare metal object. Ideally, handle the cards at a static controlled clean workstation. Also, handle the cards by the edges only. Dirt, oil, or other contaminants that may contact the cards can adversely affect circuit operation. High voltage may be present inside the operator interface. Be sure to remove all power before removing the rear cover of the operator interface
<p>1</p>	<p>Buy a SIM Card from one of the GSM/GPRS providers and insert into the option card SIM Card slot. The SIM Card slot is the rectangular slot on top of the GSM/GPRS Cellular Modem in Control Station GSM option card as shown below.</p>  <p>Note: Each Control Station GSM option card comes with a cable for communications from the main Control Station operator interface PC board. It also comes with three screws for attaching the option card to the main electronics board of the Control Station.</p>

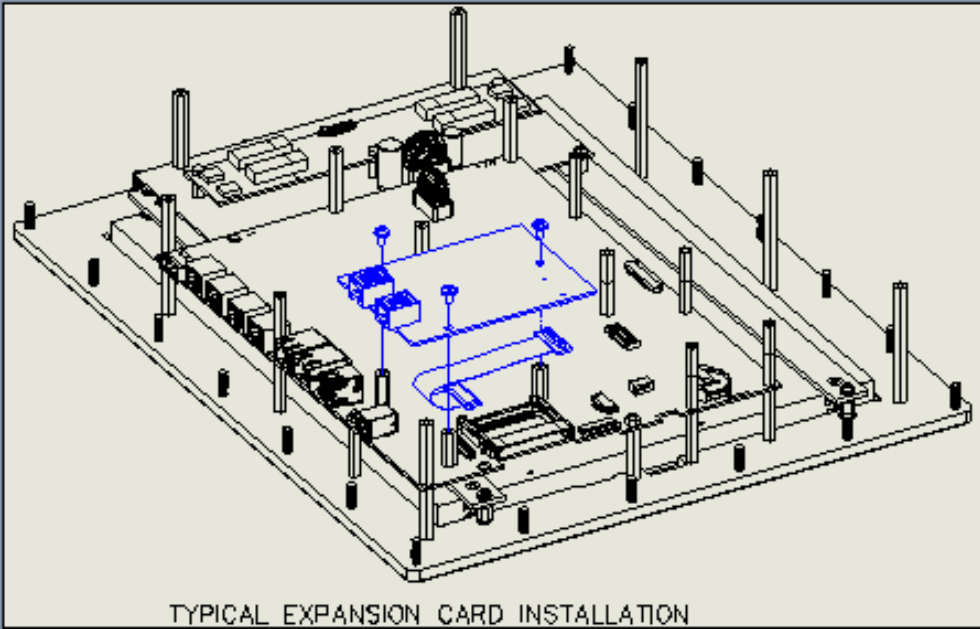
Step	Action
<p data-bbox="331 212 347 233">2</p>	<p data-bbox="453 212 1425 317">To install the option card remove all power and communication cables from the unit. The chassis ground connection to the rear cover may be left connected. The Control Station operator interface literature contains instructions for removing the rear cover; refer to the "Battery & Time Keeping" section.</p> <p data-bbox="453 342 1395 394">Using the three screws provided connect the option card to the main electronics board as shown below.</p> <div data-bbox="456 417 1430 1039" style="text-align: center;">  <p data-bbox="621 1010 1138 1035">TYPICAL EXPANSION CARD INSTALLATION</p> </div>
<p data-bbox="331 1062 347 1083">3</p>	<p data-bbox="453 1062 1409 1140">Connect the cable from the option card to CN4 for 900CS10 or CN11 for 900CS15 on the main board of the operator interface. Be sure both ends of the cables are firmly seated into their appropriate connector housing.</p>

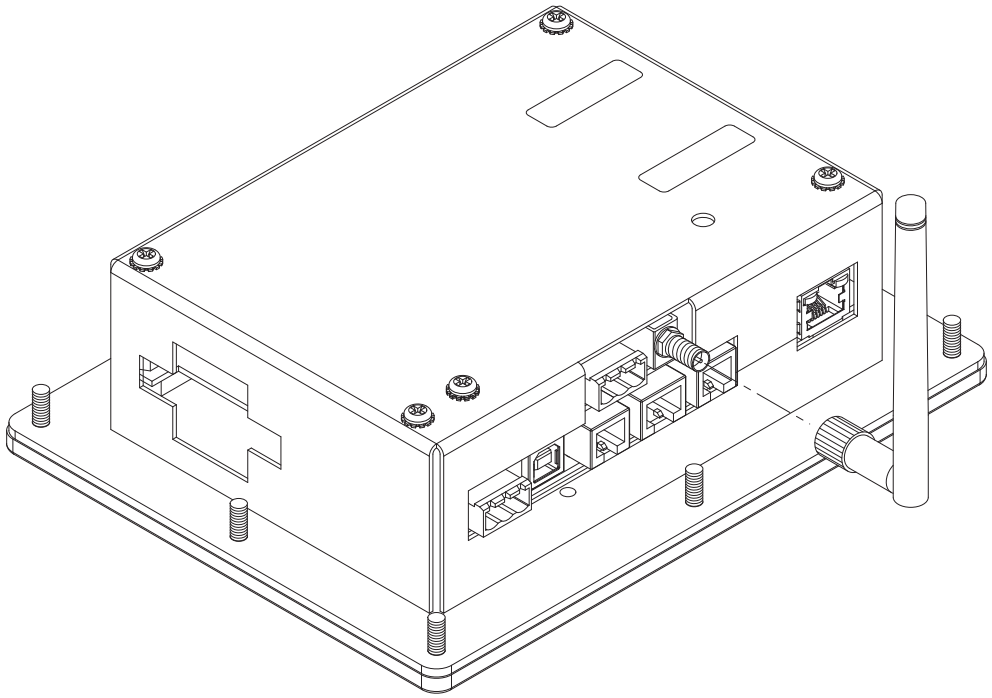
Step	Action
4	<p>Carefully replace the rear cover by reversing the previous instructions for removing the rear cover. An external antenna must be attached to the bracket on the option card. See Antenna Connector in the Specifications section for more information.</p>  <p>The diagram shows an exploded view of a rectangular device's rear cover. The cover is shown being moved towards the main device body. Several screws are shown in their respective positions on the cover and the device. On the right side of the device, there is a vertical antenna bracket. The device body has various ports and connectors visible on its rear panel, including what appears to be an antenna connector and several other ports. The cover has a rectangular cutout on the left side and a small rectangular slot on the top surface.</p>

The Option Card Label

Place the option card label on your rear cover in the space indicated by the dashed lines and labeled “COMMS EXPANSION MODULE.” The label would also display the FCC ID of the particular modem being used.

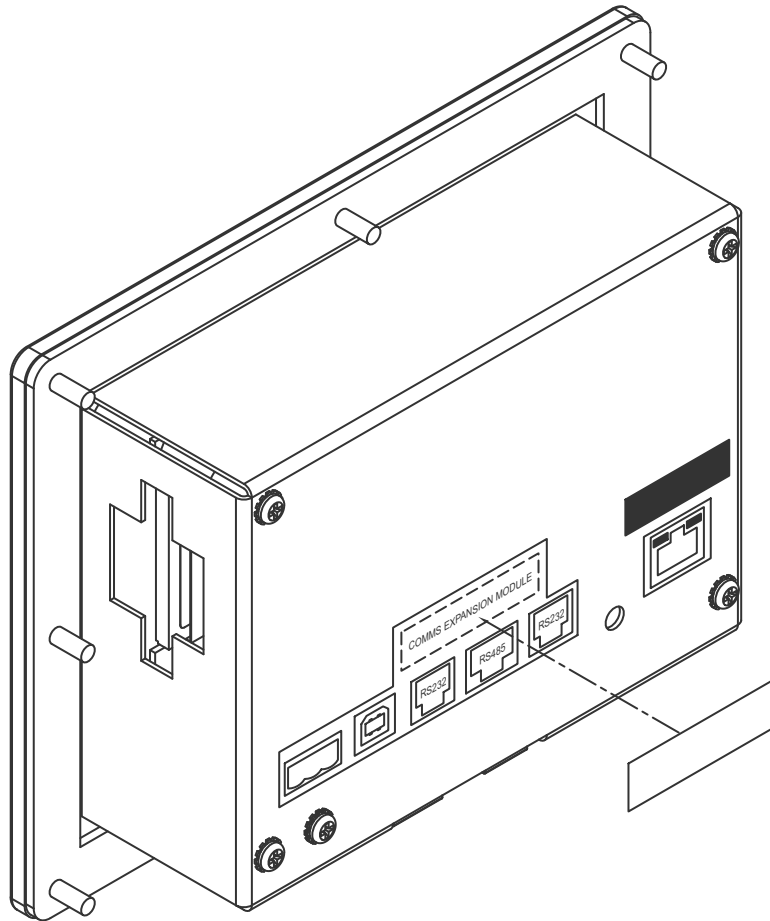

WARNING - EXPLOSION HAZARD

DO NOT DISCONNECT EQUIPMENT UNLESS POWER HAS BEEN DISCONNECTED AND THE AREA IS KNOWN TO BE NON-HARARDOUS

Power Supply Requirements

New and Existing Installations

The Control Station GSM option card must be powered by the same power source as the Control Station. Wires should be jumpered from the 24V main supply of the Control Station to the power connector of the option card. The power connections described above are absolutely essential to prevent any ground loops. The 24V power terminal connector for the Control Station GSM option card is shown below.

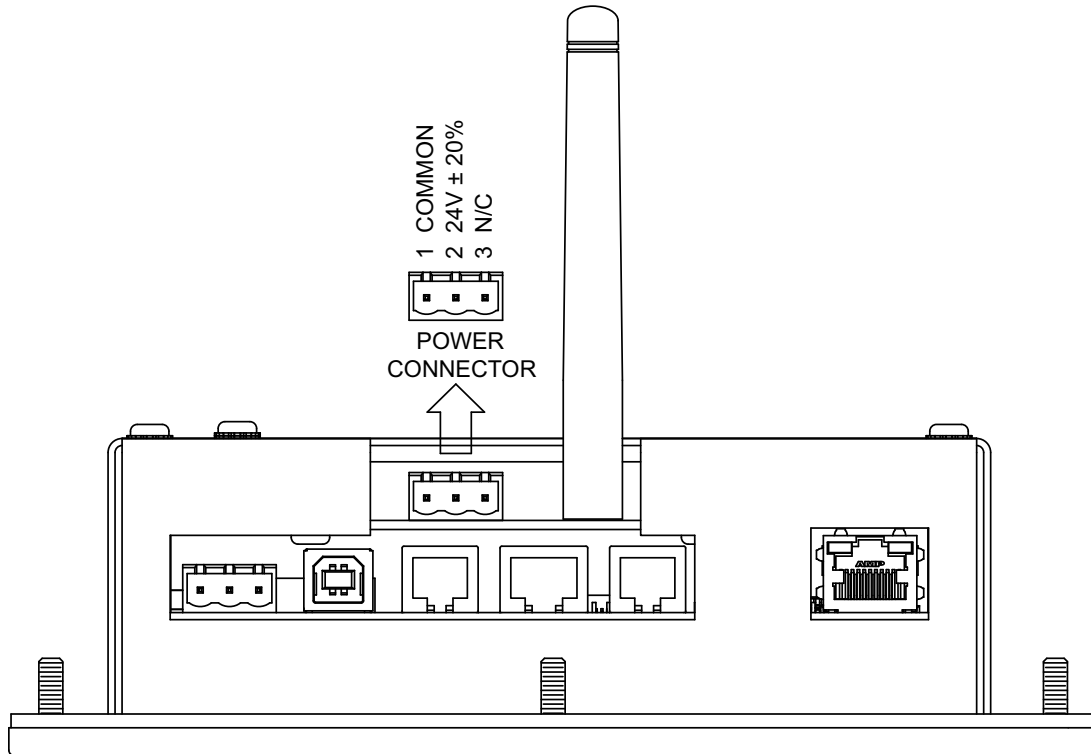

USE ONLY CLASS I, DIVISION 2 WIRING METHODS AS SPECIFIED IN THE NATIONAL ELECTRICAL CODE NFPA70 AND THE CANADIAN ELECTRICAL CODE C22.1.

Unit Operation

LED

The Control Station GSM option card has an LED through the back cover once the option card is installed. The status of the LED is described in the table below:

LED Status		
OFF	Modem in OFF mode	
ON	Permanent	Modem switched on, not registered on the network
SLOW FLASH	LED ON for 200 msec, OFF for 2 sec	Modem switched on, registered on the network
QUICK FLASH	LED ON for 200 msec, OFF for 600 msec.	Modem switched on, registered on the network and communication is in progress.

Application Note:

Control Station GSM/GPRS Cellular Modem Option Card

Applications:

The Control Station GSM/GPRS Cellular modem may be used via a Cellular Network Provider's wireless network for the following applications:

- Send SMS text messages for alarm conditions or status reports
- Send email
- Remote access the Control Station's Web Server
 - Access data logs
 - Remote viewing and remote control
- View data logs via the FTP Server
- Download an SDS database from Station Designer to Control Station

Cellular Network Provider Rate Plan

For just sending SMS text messages, only a basic Rate Plan with SMS text message service is required. For the other applications, a Data Rate Plan with the following features is required:

- Mobile Terminated Data, which allows unsolicited connection to the modem from the Internet.
- Public IP Address, which allows the modem to be accessed from the Internet and not just seen inside the Cellular Network Provider's network.
- Static IP Address
- Internet APN
- Optional: Username and Password

Configuration settings for SMS Only Communications

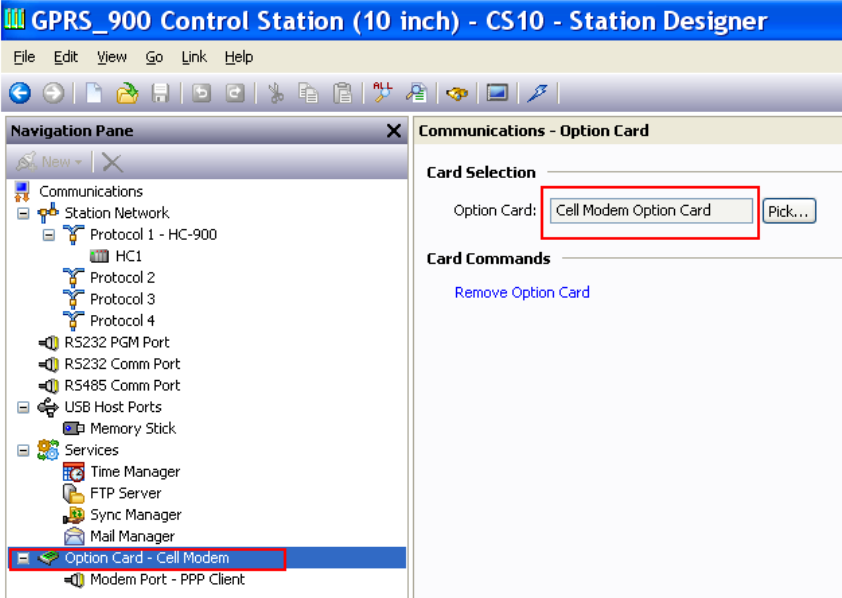
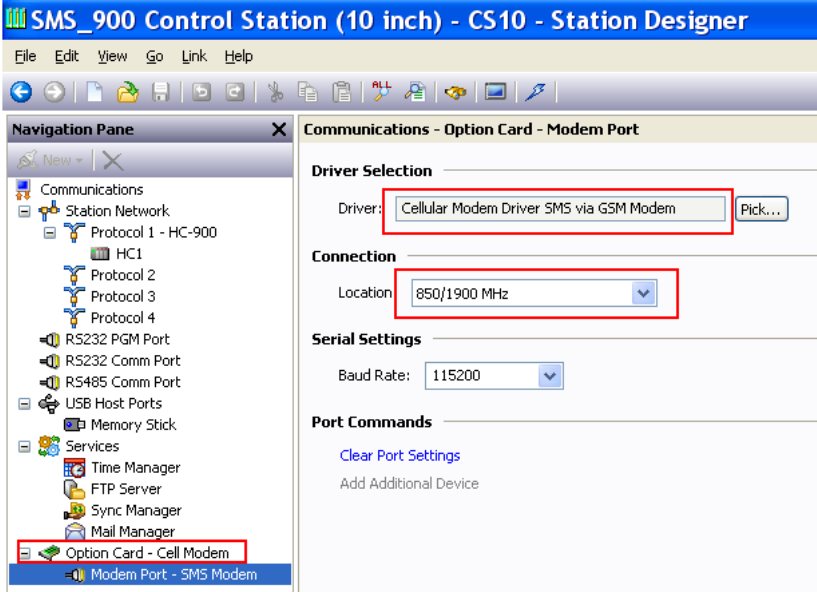
Step	Action
1	<p>Add the cellular modem card to the configuration. As shown below: under Option Card -> Card Selection -> Option Card: select Cell Modem Option Card.</p> 
2	<p>Select the Communications driver. As shown below: under Option Card -> Modem Port-SMS Modem ->Driver Selection -> Driver: select Cellular Modem Driver SMS via GSM Modem.</p>
3	<p>Select the location where the modem card will be installed. For Connection -> Location: select 850/1900 MHz (e.g. for US and Canada) ⁽¹⁾.</p>  <p>Note: For Baud Rate, select the speed at which the port should communicate. The protocol driver will have already loaded in a suitable setting, but you should check to ensure that the target device is configured to use the same speed.</p>

(1) Note that the Control Station with the GSM option card needs to be power cycled for configuration changes with respect to the GSM/GPRS frequency band to take effect.

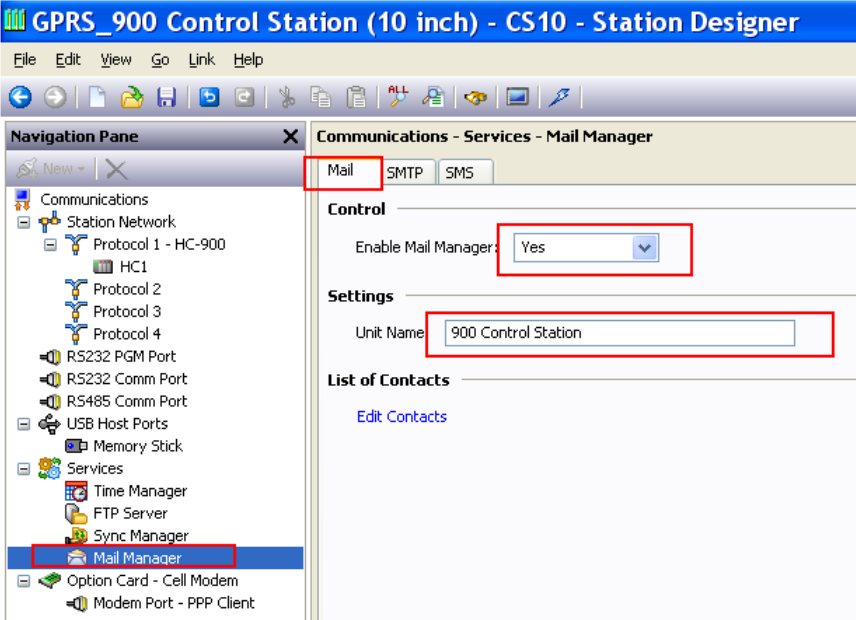
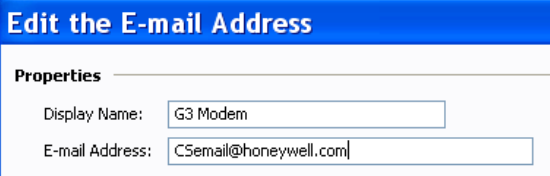
4	<p>Enable Mail Manager. As shown below: under Mail Manager -> Mail -> Control -> Enable Mail Manager: select Yes.</p>
5	<p>Under Settings -> Unit Name: enter the Control Station unit's name that will be prefixed to all alarm messages. Under List of Contacts -> Edit Contacts: enter the Names and Addresses of contacts.</p>  <p>Note: The phone number must be pre-fixed with the country code (the U.S. country code is 1) and should only be numbers; no dashes, parenthesis, or spaces. If you wish for the contact to have more than one phone number, separate them with semicolons (;). Also, do this to send an SMS message to more than one contact. An example would be 12156413927;12156414444. You may also mix and match phone numbers and emails if you have the SMTP Mail Server enabled to send emails through the Control Station's Ethernet connection.</p> <p>Set the "Mail To" property on a Data Tag's "Alarms" tab to send a message to a contact that you have created. The SendMail() function (described in the Station Designer manual) can also be used to send a message manually</p>
6	<p>Enable the SMTP Mail client. As shown below: under Mail Manager -> SMTP -> SMTP Transport -> Transport Mode: -> select Enabled.</p>
7	<p>For Server Selection: select Manual Configuration.</p>
8	<p>For Server IP Address: enter the IP Address of the SMTP Mail Server to which mail will be sent.</p>
9	<p>For Server Port Number: enter the SMTP Port number that supports this mail server.</p>
10	<p>For Domain Name enter the domain name of the SMTP Mail Server. You will normally obtain this setting from your network administrator.</p>
11	<p>For Reverse Path: The Reverse Path is used to specify the SMTP Mail Server E-mail Address that will be supplied as the originator of the messages sent by the Control Station. Enter the SMTP reverse path E-mail Address. Enter the Display Name that will be used to identify the Control Station unit that issued the email.</p> 
12	<p>Under SMTP Authentication -> Method: select Login</p>

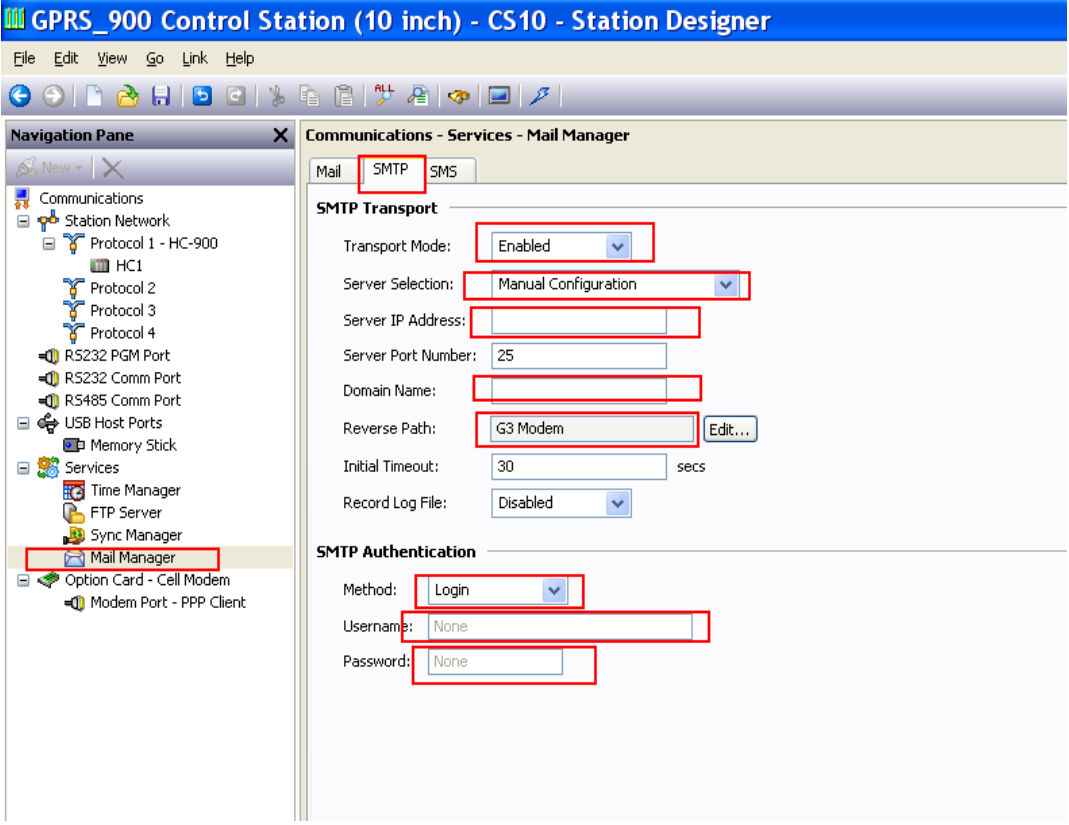
13	For Username : enter the Username required for logging on to the SMTP Mail Server.
14	<p>For Password: enter the Password required for logging on to the SMTP Mail Server.</p> 
15	Enable the SMS Mail client. As shown below: under Mail Manager -> SMS -> SMS Transport -> Transport Mode : select Enabled .
16	<p>For Message Relay: select Enabled.</p> <p>Note: Message Relay is used when you have a Contact with multiple cell phone numbers.</p> <p>When it is enabled, and an Alarm occurs that sends an SMS message to several numbers, if one of those recipient numbers replies to the Alarm message, the Control Station will relay that message to the other cell phone numbers that received the Alarm SMS message</p>

17

For **On Message**: enter an action to be performed when an SMS is received. A system variable tag called "Data" holds the contents of the SMS while this action is executed, allowing the message to be passed to a program for further processing. The system tag "Data" exists in the database and does not have to be created by the user. The contents of "Data" are the phone number the SMS came from and the message separated by a colon (:). So a message of Hello World from 215-641-3927 would be the string: "12156413927:Hello World". As shown in the example below, the user can enter an action string tag to which the contents of "Data" are assigned. The string tag can then be used in a Text Box to display the message.

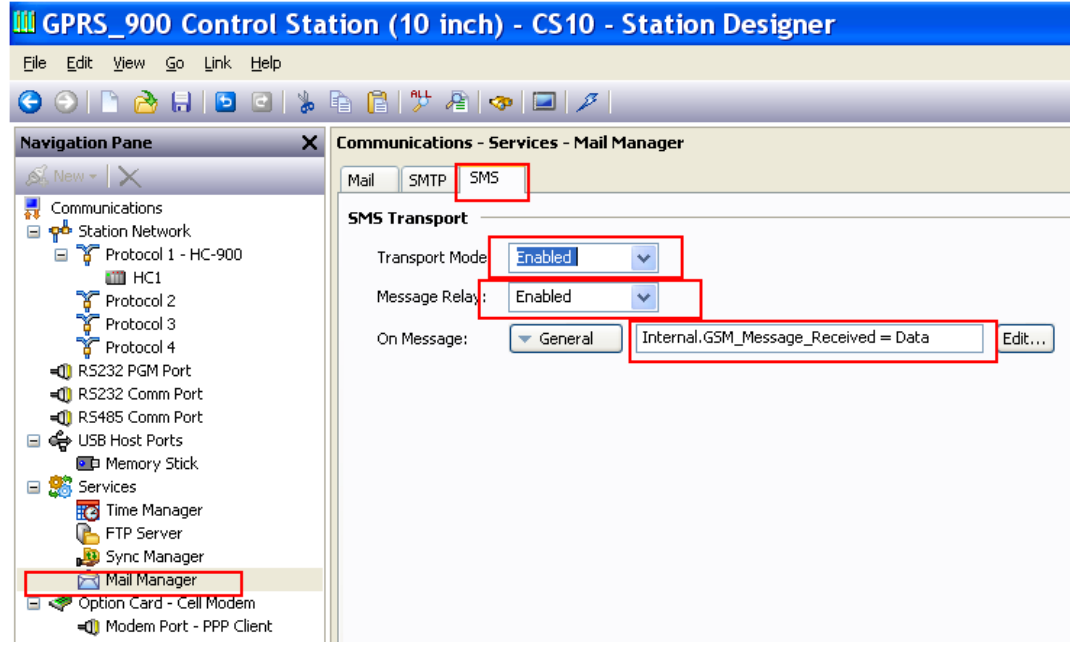

Configuration settings for GPRS Data Communications

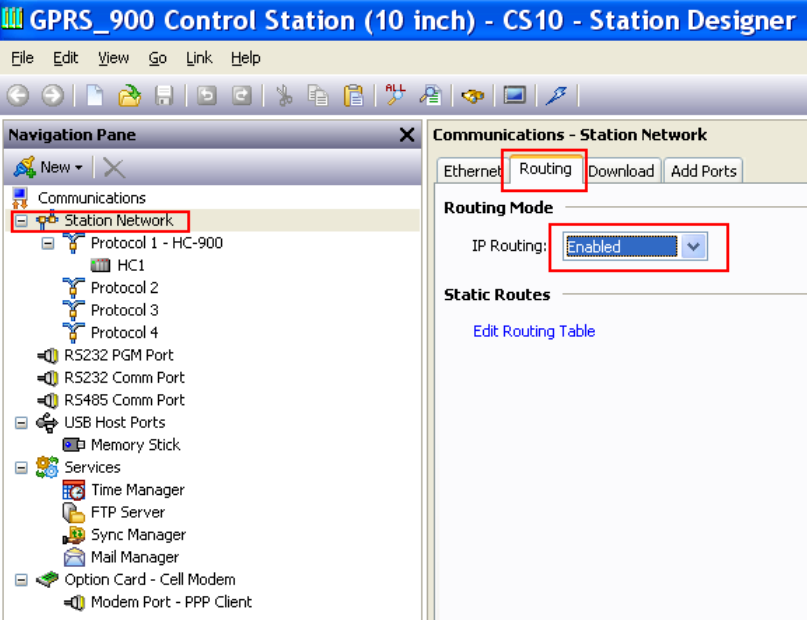
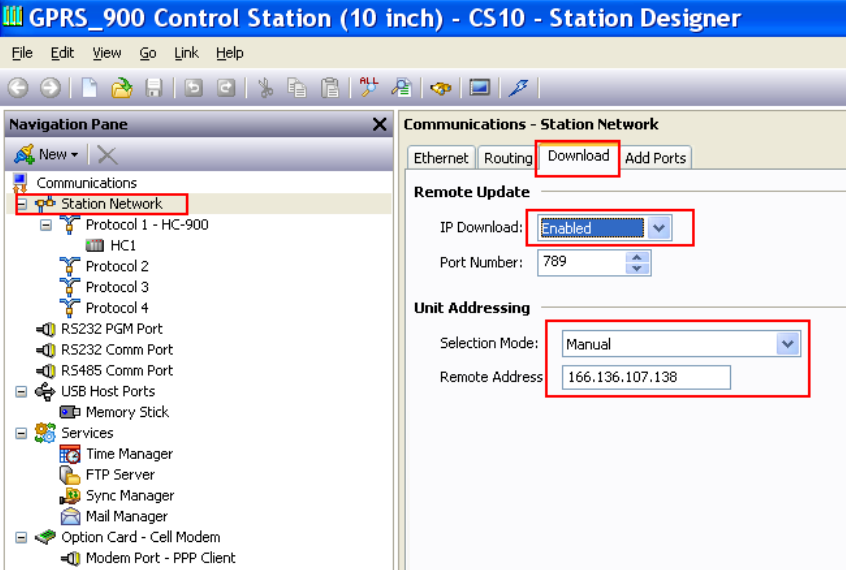
Step	Action
1	As shown below: select Routing under Station Network in the Communications option in the Navigation Pane. If Routing is enabled, packets will be routed between the Control Station's various IP interfaces.
2	<p>Under Routing Mode -> IP Routing: select Enabled.</p>  <p>The screenshot shows the 'GPRS_900 Control Station (10 inch) - CS10 - Station Designer' interface. In the 'Navigation Pane' on the left, 'Station Network' is selected. In the 'Communications - Station Network' pane on the right, the 'Routing' tab is active, and 'IP Routing' is set to 'Enabled'.</p>
3	As shown below: select Download under Station Network in the Communications option in the Navigation Pane.
4	Under Remote Update -> IP Download : select Enabled . This enables the Control Station's firmware and configuration to be updated.
5	Under Unit Addressing -> Selection Mode : select Manual to allow an IP address to be entered.
6	<p>For Remote Address: enter the IP Address of the Cellular Modem that was obtained from the service provider.</p>  <p>The screenshot shows the 'GPRS_900 Control Station (10 inch) - CS10 - Station Designer' interface. In the 'Navigation Pane' on the left, 'Station Network' is selected. In the 'Communications - Station Network' pane on the right, the 'Download' tab is active. Under 'Remote Update', 'IP Download' is set to 'Enabled' and 'Port Number' is 789. Under 'Unit Addressing', 'Selection Mode' is set to 'Manual' and 'Remote Address' is 166.136.107.138.</p>

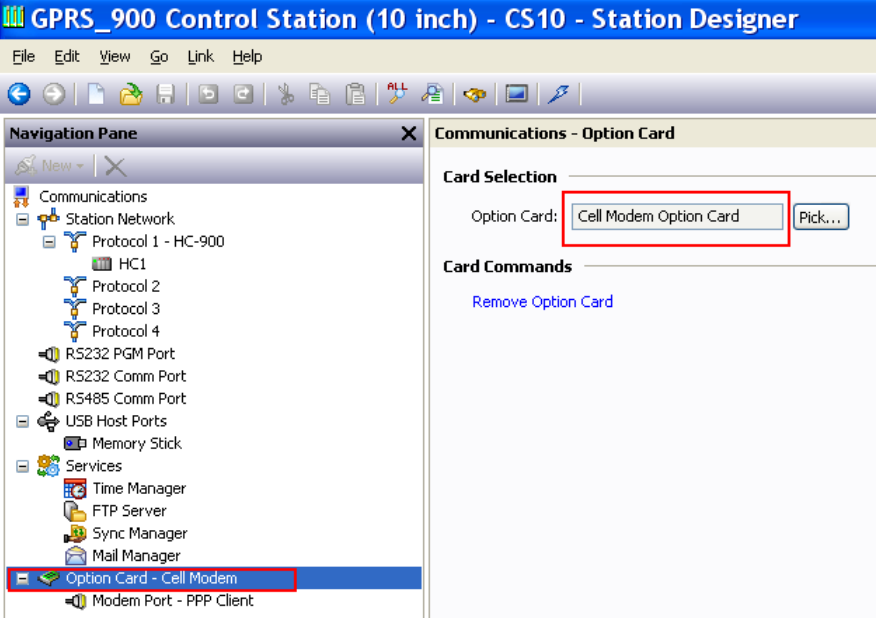
Step	Action
7	<p>As shown below: under Option Card -> Card Selection -> Option Card: select Cell Modem Option Card.</p> 
8	As shown below: under Modem Port -> Driver Selection -> Driver : select Cellular Modem Driver PPP and Modem Client .
9	Under Connection -> Connect Using : -> select GSM Modem via GPRS .
10	For Connection Type : select Permanent to allow the modem to always be connected to the Internet.
11	Check No Firewall to allow incoming connections.
12	For Location : select 850/1900 MHz ⁽¹⁾
13	Number or APN : enter the APN supplied by the Cellular Network Provider.
14	For SMS Support : select Enabled .
15	Under Authentication -> Logon Username : enter the User Name supplied by the Cellular Network Provider.

(1) Note that the Control Station with the GSM option card needs to be power cycled for configuration changes with respect to the GSM/GPRS frequency band to take effect.

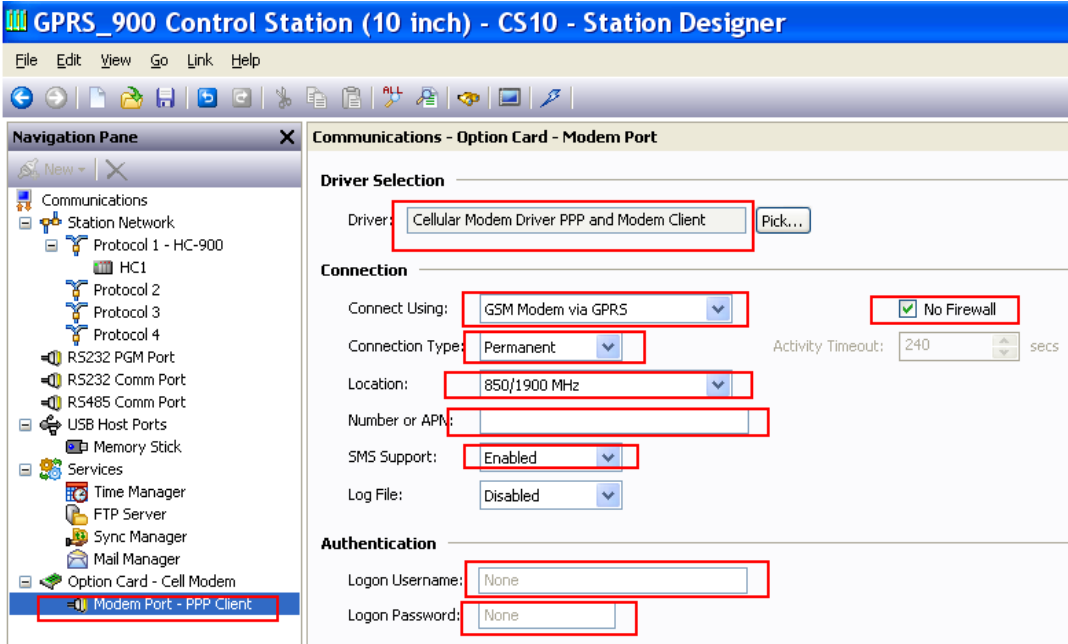
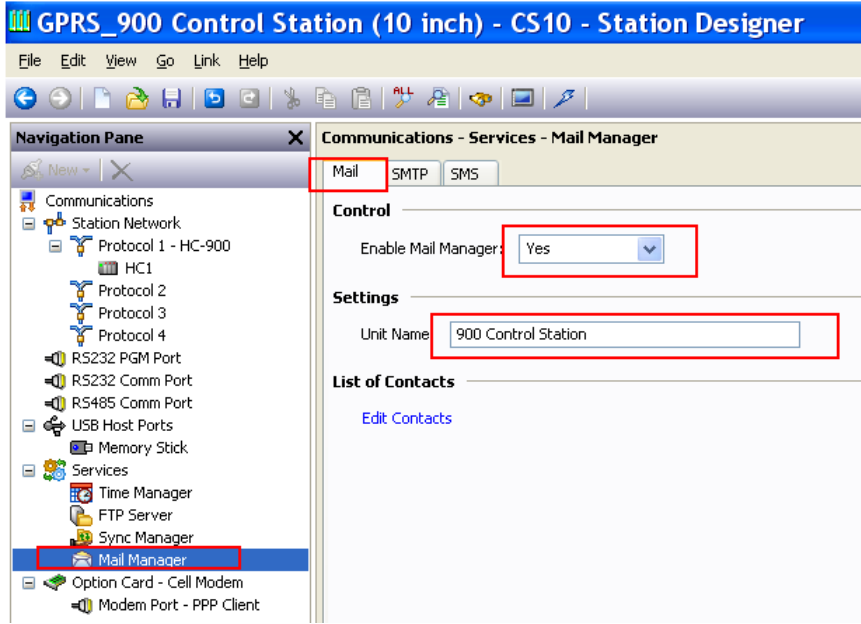
<p>16</p>	<p>For Logon Password: enter the Password supplied by the Cellular Network Provider.</p> 
<p>17</p>	<p>As shown below: under Mail Manager -> Mail -> Control -> Enable Mail Manager: select Yes.</p>
<p>18</p>	<p>Under Settings -> Unit Name: enter the Control Station unit's name that will be prefixed to all alarm messages.</p>
<p>19</p>	 <p>Note: SMS is not supported while connected to the GPRS network</p>
<p>20</p>	<p>As shown below: under Mail Manager -> SMTP -> SMTP Transport -> Transport Mode: -> select Enabled.</p>
<p>21</p>	<p>For Server Selection: select Manual Configuration.</p>
<p>22</p>	<p>For Server IP Address: enter the IP Address of the SMTP Mail Server.</p>

23	For Server Port Number : enter the SMTP Port number that supports this mail server.
24	For Domain Name enter the domain name.
25	<p>For Reverse Path: The Reverse Path is used to specify the SMTP Mail Server E-mail Address that will be supplied as the originator of the messages sent by the Control Station. Enter the SMTP reverse path E-mail Address. Enter the Display Name that will be used to identify the Control Station unit that issued the email.</p> <div data-bbox="613 394 1198 579" style="border: 1px solid black; padding: 5px;"> <p style="text-align: center; background-color: #0056b3; color: white; margin: 0;">Edit the E-mail Address</p> <hr/> <p>Properties</p> <p>Display Name: <input type="text" value="G3 Modem"/></p> <p>E-mail Address: <input type="text" value="CSemail@honeywell.com"/></p> </div>
26	Under SMTP Authentication -> Method : select Login .
27	For Username : enter the Username required for logging on to the SMTP Mail Server. Note that this is not the same as the optional Username required by the Cellular Network Provider.
28	<p>For Password: enter the Password required for logging on to the SMTP Mail Server. Note that this is not the same as the optional Password required by the Cellular Network Provider.</p> <div data-bbox="370 804 1442 1621" style="border: 1px solid black; padding: 5px;"> <p style="background-color: #0056b3; color: white; margin: 0;">GPRS_900 Control Station (10 inch) - CS10 - Station Designer</p> <p style="margin: 0;">File Edit View Go Link Help</p> <hr/> <div style="display: flex;"> <div style="flex: 1; border-right: 1px solid black; padding-right: 5px;"> <p>Navigation Pane</p> <ul style="list-style-type: none"> Communications Station Network <ul style="list-style-type: none"> Protocol 1 - HC-900 <ul style="list-style-type: none"> HC1 Protocol 2 Protocol 3 Protocol 4 RS232 PGM Port RS232 Comm Port RS485 Comm Port USB Host Ports Memory Stick Services <ul style="list-style-type: none"> Time Manager FTP Server Sync Manager Mail Manager Option Card - Cell Modem <ul style="list-style-type: none"> Modem Port - PPP Client </div> <div style="flex: 2; padding-left: 5px;"> <p>Communications - Services - Mail Manager</p> <p>Mail SMTP SMS</p> <hr/> <p>SMTP Transport</p> <p>Transport Mode: <input type="text" value="Enabled"/></p> <p>Server Selection: <input type="text" value="Manual Configuration"/></p> <p>Server IP Address: <input type="text"/></p> <p>Server Port Number: <input type="text" value="25"/></p> <p>Domain Name: <input type="text"/></p> <p>Reverse Path: <input type="text" value="G3 Modem"/> <input type="button" value="Edit..."/></p> <p>Initial Timeout: <input type="text" value="30"/> secs</p> <p>Record Log File: <input type="text" value="Disabled"/></p> <hr/> <p>SMTP Authentication</p> <p>Method: <input type="text" value="Login"/></p> <p>Username: <input type="text" value="None"/></p> <p>Password: <input type="text" value="None"/></p> </div> </div> </div>
29	As shown below: under Services -> FTP Server -> Control -> Enable FTP Server : select Yes .

30

Under Settings -> Anonymous Access: select Read-Only.

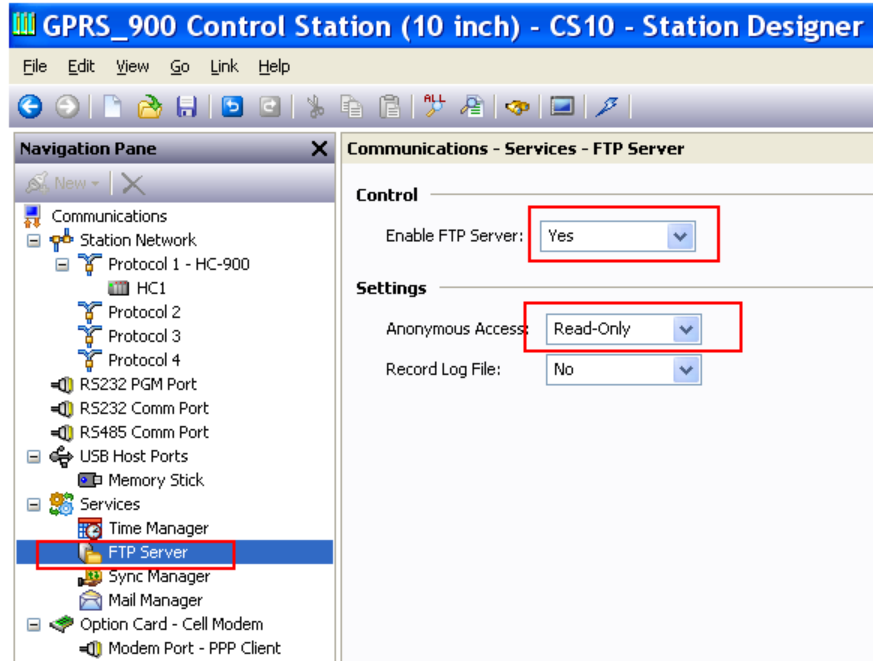

Specifications – apply to all models unless specified.

Power Requirements	Jumper from the 24 V main supply of the Control Station to the option card.
Environmental	<p>Operating Temperature Range: 0 to 50 °C</p> <p>Storage Temperature Range: -20 to 80 °C</p> <p>Operating and Storage Humidity: 80% maximum relative humidity (non-condensing) from 0 to 50°C.</p> <p>Altitude: Up to 2000 meters.</p>
Antenna Connector	<p>SMA Female connector requires:</p> <ul style="list-style-type: none"> • Quad-band antenna (850/900/1800/1900 MHz) for global support. <p>The antenna cable should be 50Ω impedance, RG178/U or RG174/U type and be able to connect to the RSMA (Male) jack bulkhead. The antenna could be horizontal, vertical or right angled. Longer antenna cable would equate to signal loss.</p>
Safety	<p>UL Listed, File #E245515, UL61010-1, ANSI/ISA 12.12.01-2007, CAN/CSA 22.2 No. 61010.1, CSA 22.2 No. 213-M1987 and File #E179259, UL61010-1, CAN/CSA 22.2 No. 61010-1</p> <p>Listed by Und. Lab. Inc. to U.S. and Canadian safety standards</p> <p>IECEE CB Scheme Test Report #E179259-A1-CB-3</p> <p>Issued by Underwriters Laboratories Inc.</p> <p>IEC 61010-1, EN 61010-1: Safety requirements for electrical equipment for measurement, control and laboratory use, Part 1.</p> <p>UL, CSA and FM Class I, Div 2 Groups A,B,C and D</p>
Electromagnetic Compatibility	<p>Emissions and Immunity to EN 61326: Electrical Equipment for Measurement, Control and Laboratory use.</p> <p>Immunity to Industrial Locations: Reference Control Station unit specifications</p> <p>Emissions:</p> <p>Emissions EN 55011 Class A ⁽¹⁾</p>
Construction	Installation Category I, Pollution Degree 2.
Installation requirements	Card must be installed inside the Control Station with the hardware provided. See “Installing the Control Station GSM Option Card” for more details.
Weight	3.0 oz (85.41g).

⁽¹⁾ The GSM option card has been tested and found to comply with the limits for a Class A digital device, pursuant to part 15 of the FCC rules.

TROUBLESHOOTING YOUR CONTROL STATION GSM OPTION CARD

If for any reason you have trouble operating, connecting, or simply have questions concerning your new Control Station GSM option card, contact Honeywell's technical support. (email: HFS-TAC-Support@Honeywell.com)

Warranty/Remedy

Honeywell warrants goods of its manufacture as being free of defective materials and faulty workmanship. Contact your local sales office for warranty information. If warranted goods are returned to Honeywell during the period of coverage, Honeywell will repair or replace without charge those items it finds defective. The foregoing is Buyer's sole remedy and is **in lieu of all other warranties, expressed or implied, including those of merchantability and fitness for a particular purpose**. Specifications may change without notice. The information we supply is believed to be accurate and reliable as of this printing. However, we assume no responsibility for its use.

While we provide application assistance personally, through our literature and the Honeywell web site, it is up to the customer to determine the suitability of the product in the application.



Honeywell
AUTHORIZED DISTRIBUTOR

De Gidts & Feldman BV
The Netherlands
www.dgfg.nl



De Gidts & Feldman
INSTRUMENTATION & FILTRATION

Honeywell

Honeywell Process Solutions
512 Virginia Drive
Fort Washington, PA 19034
www.honeywell.com/ps/hfs