

Flexible

- Compatible with all Honeywell Analytics gas sensors
- Allows selection of best sensor technology for each application
- Choice of all industry standard output signals
- Ability to adapt configuration as site needs change
- Future-proofed for any new output standards

Common Transmitter Platform

- Simplified and reduced cost of installation
- Reduced training time and cost
- Less chance of misinterpreting messages
- Less chance of incorrectly changing settings
- Reduced maintenance, spares, stock and cost

Global Approvals

- European, US and Canadian
- Compliant with ATEX, UL and CSA standards
- ATEX, UL and CSA performance approval
- IEC61508 SIL 2

Easy to Use

- Easy read multilingual backlit LCD with text, bar graph, digits and icons
- Local or remote sensor mounting options
- Selectable sink, source or isolated 4-20mA output to suit preferred wiring topology
- HART® communications as standard for remote diagnostics/configuration

Reduced Operational Costs

- Fully configurable via non-intrusive magnetic switches
- No hot work permit needed
- Hot swap toxic and Oxygen sensor cartridges
- Serviceable catalytic and IR sensors
- Auto-inhibit during maintenance

Friendly Installation

- Integral surface mounting lugs or optional pipe or ceiling mounting brackets
- 5 x M25 or ¾" NPT cable/conduit/sensor entries
- Plug-in 'POD' module removes to give access to terminal area
- Removable plug/socket type terminal blocks for ease of wiring

Typical Applications

- Offshore oil and production platforms
- Oil and gas exploration and drilling
- Refineries
- Chemical and petrochemical plants
- Onshore oil and gas terminals
- Gas transmission
- Power stations

XNX is an extremely flexible transmitter that can be configured to accept an input from any of the Honeywell Analytics range of gas sensor technologies. It can also be configured to provide a wide variety of industry standard output signals. This enables users to have a single type of interface to all their gas detection needs, even when different types of detectors are employed, to most effectively address the different gas detection applications on site.



The most effective gas detection systems often employ a variety of detection technologies including point flammable detectors (both catalytic and infrared type), toxic and Oxygen electrochemical cell type detectors and open path infrared detectors. XNX provides a common transmitter interface to all of these and can be configured to provide industry standard signal outputs to match the individual requirement of each application or the preferred site standard. If site output standards change, XNX can be reconfigured to provide the new required output. XNX has also been future-proofed by having the ability to have other output modules fitted as new output standards are developed and adopted by industry.

Having a common transmitter platform for all your gas detectors brings further benefits. Common tools and installation methods simplifies and reduces cost of installation. The common user interface makes operation faster to learn and easier to navigate, thus reducing time needed for training as well as reducing the chance of incorrectly interpreting messages or incorrectly changing settings. Common spare parts also mean reduced maintenance spares stock levels and cost for all detectors.

XNX allows you to apply the most appropriate gas detection technologies for each application, standardise the interface to those detectors and has the flexibility to provide the required signal outputs. With XNX the answer is always yes.

XNX Universal Transmitter

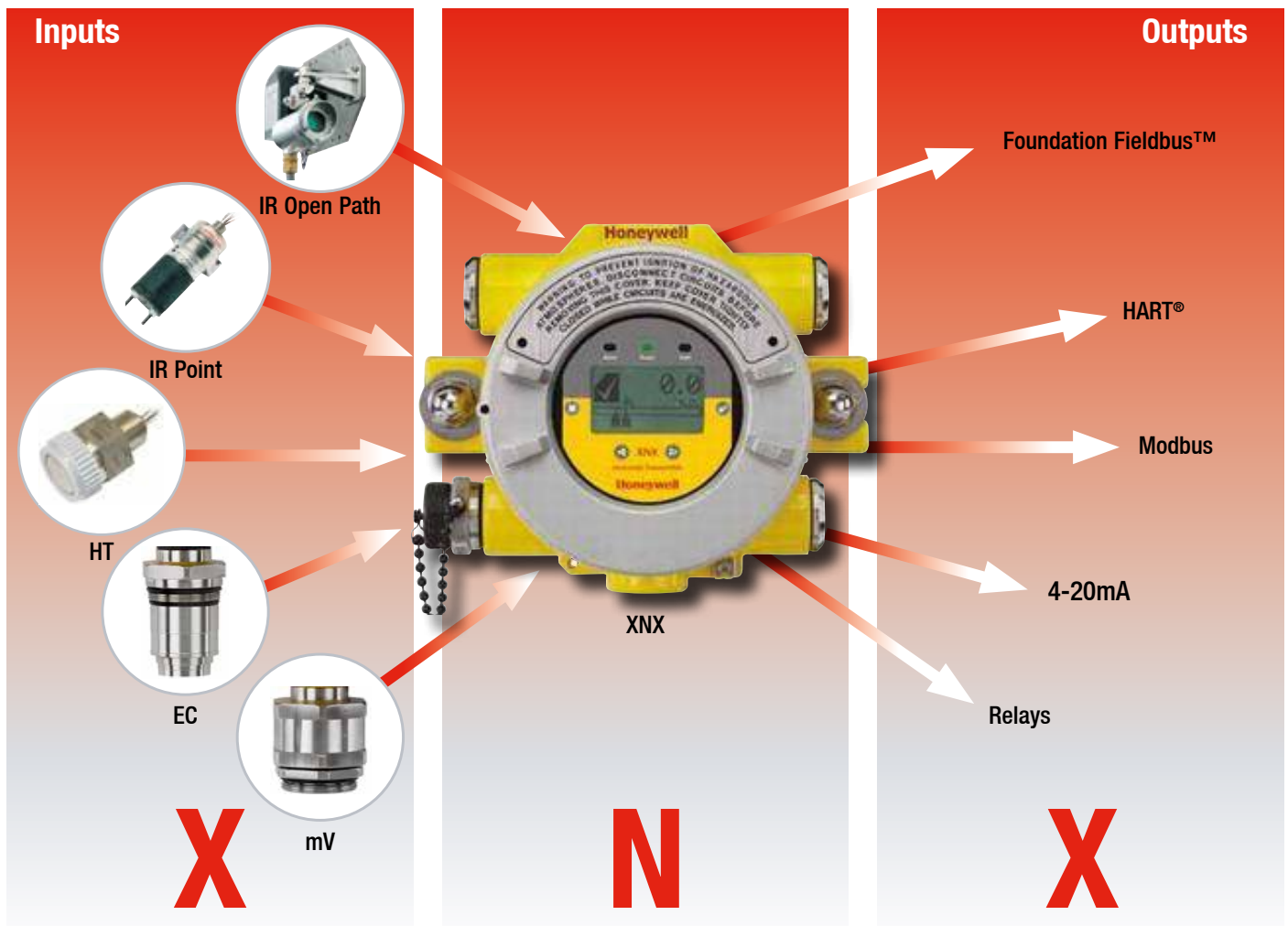

XNX Transmitter

XNX has Worldwide hazardous area and performance approvals and is housed in a flameproof enclosure that is available in either painted marine grade aluminum alloy or stainless steel 316 versions. A large backlit multilingual LCD clearly indicates the unit's status using a combination of text, digits and icons. Users can modify its operation using the LCD and magnet switches without ever needing to open the unit. An optional local IS HART® terminal port is also available. Both enable one man, non-intrusive, operation and reduce routine maintenance time and costs. Local LEDs are also provided to indicate the unit's status at a glance.

XNX Transmitter Sensor Compatibility

XNX is compatible with all of the Honeywell Analytics range of industrial fixed gas sensors including Searchline Excel, Searchpoint Optima Plus, Sensepoint (HT and PPM) and Model 705. For further information on these sensors, please refer to their individual datasheets.

The Multi Purpose Detector (MPD) is a serviceable stainless steel sensor housing with plug-in catalytic and infrared sensor cartridges. The catalytic sensors measure flammable gases in the range 0-100%LEL and the infrared sensors measure Hydrocarbons in the range 0-100%LEL, or Methane 0-100%LEL (or 0-5%Vol) and CO₂ 0-5%Vol. See the specifications section for full details of the MPD sensor.

The XNX EC sensor is also a serviceable stainless steel sensor with a wide range of toxic and Oxygen plug-in sensor cartridges. The XNX EC sensor interface to the XNX transmitter is intrinsically safe, allowing the sensors to be 'hot swapped' without the need for a hot work permit. This reduces the cost of ownership by reducing the cost and time to service the detector.



XNX MPD Sensor



XNX EC Sensor

XNX Universal Transmitter

XNX Transmitter Configuration

XNX has three basic personalities (configurations) which support different types of sensor. The personality boards and optional output interfaces are enclosed in the electronics POD (Personality, Options and Display). The POD determines the XNX transmitter behaviour based on the sensor type attached to it and the selected output options.

The mV (millivolt) personality is used for all mV signal input sensors including MPD, Sensepoint HT, PPM and the Model 705. The EC (Electrochemical cell) personality is for use with the XNX EC toxic and Oxygen sensors. The IR (infrared) personality is for use with the Searchline Excel open path and Searchpoint Optima Plus point infrared gas detectors.

The table below shows the three basic XNX transmitter configurations and the sensors each supports.

XNX Transmitter Main Components

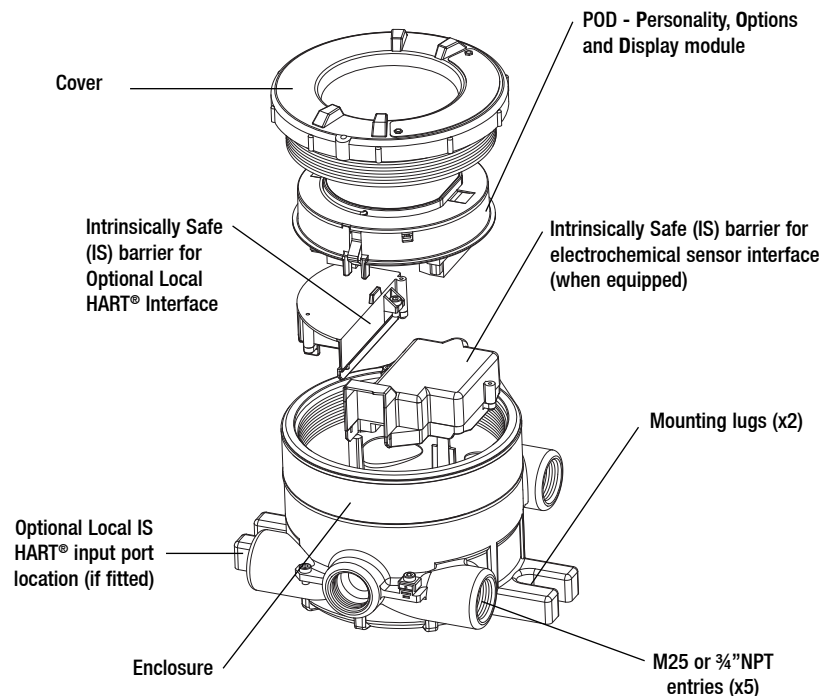

Personality	XNX mV					XNX EC	XNX IR	
Sensors Supported	MPD Flammable Catalytic	MPD Flammable Infrared (Flam and CO ₂)	Sensepoint HT (High Temperature)	Sensepoint PPM	Model 705 HT (High Temperature)	XNX Toxic and Oxygen Sensors	Searchpoint Optima Plus	Searchline Excel
Product Image								

Mechanical Installation Options

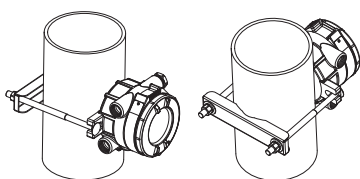

Vertical or Horizontal Pipe Mounted (Using Optional Pipe Mounting Bracket)

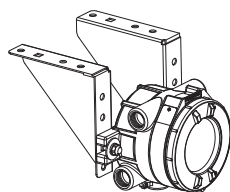

Ceiling Mount

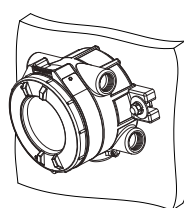

Surface Mounted

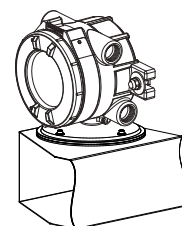

Duct Mounted

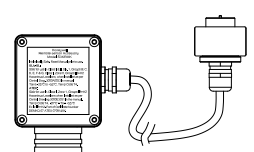

Optional remote sensor mounting kit for XNX EC sensor

Electrical

Electrical

XNX is designed for use in potentially explosive atmospheres. As such, installation should follow national guidelines using suitable mechanically protected cable and glands (M25 or ¾" NPT) or conduit. Use 0.5mm² (20AWG) to 2.5mm² (~13AWG) cross sectional area cable as needed to ensure minimum operating voltage at the detector, depending on installed cable length. Five M25 (ATEX/IECEx certified version) or ¾"NPT entries (UL/CSA version) are provided. Entries are also used for either locally mounting a sensor or for accepting the cable/conduit from a remotely mounted sensor.

Typical Maximum Cable Lengths

The maximum cable length between a controller and detector is dependent upon:

- The minimum guaranteed supply voltage from the controller
- The minimum operating voltage of the detector
- The maximum current draw of the detector
- The input impedance of the controller
- The resistance of the cable

The typical maximum cable length table (right) is for an XNX mV with an MPD catalytic sensor or an XNX EC with an XNX EC sensor fitted. It also assumes a single transmitter being powered from a PSU. Refer to the manual for examples of other variants and cable topology.

Cable Size	Max Cable Distance Meters (Feet)
1.0mm ² (18AWG*)	347m (1140')
1.5mm ² (16AWG*)	551m (1810')
2.0mm ² (14 AWG*)	880m (2890')
2.5mm ² (12AWG*)	1408m (4620')

*nearest equivalent

Terminals on POD Module

All sensor connections and option module connections are made at the terminal blocks mounted on the rear of the removable POD module.

The terminals provided are dependent on which of the three basic personalities have been selected plus the options selected.

The tables below show the different terminal connections for each of the available POD personality boards and options boards.

	S1	S2
Source	Down	Up
Sink	UP	Down
Isolated	Down	Down

Example mV POD with Relay Option

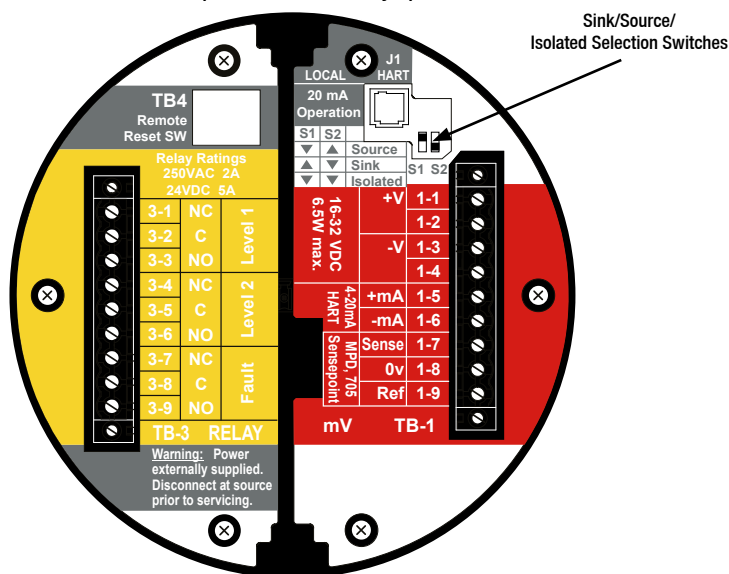

Options Boards						
Terminal	Relay		Modbus RTU		Foundation Fieldbus	
TB3	Marking	Connection	Marking	Connection	Marking	Connection
3-1	NC	Alarm 1 Normally Closed	+	Power In +	F+	FF Data In +
3-2	C	Alarm 1 Common	+	Power Out +	F+	FF Data Out +
3-3	NO	Alarm 1 Normally Open	-	Power In -	F-	FF Data In -
3-4	NC	Alarm 2 Normally Closed	-	Power Out -	F-	FF Data Out -
3-5	C	Alarm 2 Common	A	Modbus A In	FS	FF Shield In
3-6	NO	Alarm 2 Normally Open	A	Modbus A Out	SS	FF Shield Out
3-7	NC	Fault Normally Closed	B	Modbus B In		
3-8	C	Fault Common	B	Modbus B Out		
3-9	NO	Fault Normally Open	S	Modbus Drain In		
3-10	-	-	S	Modbus Drain Out		
TB4	Marking	Connection				
		Remote reset switch				
		Remote reset switch				

Personality Boards				
Terminal	Marking			Connection
TB1	EC	mV	IR	
1-1	+V	+V	+V	+VE Supply (18-32VDC)
1-2	+V	+V	+V	+VE Supply (18-32VDC)*
1-3	-V	-V	-V	-VE supply (OVDC)
1-4	-V	-V	-V	-VE supply (OVDC)*
1-5	+mA	+mA	+mA	Current & HART output 4-20mA +
1-6	-mA	-mA	-mA	Current & HART output 4-20mA -
1-7	-	Sense	+r	Sensor Connection
1-8	-	0V	-lr	Sensor Connection
1-9	-	Ref	Sig	Sensor Connection
TB2	EC	mV	IR	
2-1	-	-	Com A	Optima/Excel Modbus A Comms
2-2	-	-	Com B	Optima/Excel Modbus B Comms

*Terminal block jumper required

Technical Summary

XNX Transmitter			
Use	High specification universal transmitter for use with a wide range of Honeywell Analytics local or remote gas detectors for the detection of flammable, toxic and Oxygen gas hazards. Suitable for use in Zone 1 and 2 or Zone 21 and 22 hazardous areas, and North American Class I and II Division 1 or 2 areas.		
Construction			
Material	Housing: 5-coat marine finish painted aluminium alloy or 316 stainless steel		
Weight (Approx.)	Aluminium alloy: 2.8kg (6.2lbs). 316 stainless steel: 5kg (11lbs)		
Mounting	Surface mount via integral mounting lugs. Optional pipe mounting kit suitable for Ø100mm to 150mm (Ø4" to 6") pipe. Optional ceiling mounting bracket		
Entries	5 conduit/cable entries (2 right, 2 left, 1 bottom). Entry size M25 for ATEX/IECEx versions or ¾"NPT for UL/CSA certified versions		
Dimensions	160mm x 197mm x 114mm (6.1" x 7.8" x 4.5")		
Environmental			
IP Rating	IP66 in accordance with EN60529:1992. NEMA 4X		
Operating Temperature	-40°C to +65°C (-40°F to +149°F)		
Operating Humidity	0-99%RH (non condensing)		
Operating Pressure	90-110kPa		
Storage Conditions	-40°C to 75°C (-40°F to 167°F), 0-99% non-condensing		
Electrical			
Input Voltage Range	EC and mV versions 16 to 32Vdc, IR version 18 to 32 Vdc (24Vdc nominal)		
Max Power Consumption	XNX EC (Toxic): 6.2 watts XNX mV (Catalytic or IR cell): 6.5 watts XNX IR with Searchpoint Optima Plus: 9.7 watts XNX IR with Searchline Excel Receiver: 13.2 watts		
Current Output	Fully configurable isolated 4-20mA & HART® output module providing current sink, current source and isolated modes of operation (supports HART® 6.0 protocol) supplied as standard Default current output settings: ≥0.0<1.0mA Fault 4.0 mA to 20.0mA Normal gas measurement 2.0 mA or 4.0 mA (17.4mA) Inhibit (during configuration/user settings) HART® mode: 3mA Fault/Warning 4-20mA Normal gas measurement 22.0mA Maximum over range The available output range for Inhibit, Warning, Beam Blocked and Low Signal is from 1 to 4mA. For an over range condition, the range is 20 to 22mA		
4-20mA Signal Accuracy	+/-1% Full Scale		
Functions Supported by HART®	Gas reading Gas name and units of measurement 4-20mA signal level General/device information Installation Configuration Forcing of 4-20mA output	Detailed sensor information including: Optical signal level Dynamic reserve (Searchline Excel only) Raw reading 24V supply voltage Temperature	Calibration and configuration status Detailed fault and warning information Fault and alarm history Zero calibration
Terminals	Cage style pluggable with retaining screws for wire diameter 0.5mm ² to 2.5mm ² (approx. 20AWG to 14AWG)		
Certification			
European	ATEX: Ⓜ II 2 (1) G Ex d [ja IIC Ga] IIC T4/T6 Gb Ⓜ II 2 (1) D Ex tb [ja IIIC Da] IIIC T85 Db		
International	IECEx: Ex d [ja IIC Ga] IIC T4/T6 Gb Ex tb [ja IIIC Da] IIIC T85 Db		
North American	UL: Class I, Div 1, Groups A, B, C, and D; Class II, Div. 1 Groups F & G / Class 1, Zone 1 Groups IIB + H2; Class II, Zone 20 & 21 FM: AEx D [ja IIC] IIB + H2 T6 -40°C ≤ Tamb ≤ 65°C		
Canadian	CSA: Class I, Div 1, Groups B, C, and D; Class II, Div. 1 Groups F & G / Class I, Zone 1 Groups IIB + H2		
EMC	EN50270:2006 EN61000-6-4:2007		
Performance	Europe – ATEX, EN45544, EN50104, EN50271:2010, EN13980, EN60079-29-1 North America – UL 913, UL 1203, CSA 22.2 No. 152 IEC61508 (SIL Assessment, SIL 2), IECEx OD 005		
Local IS HART® Port (Optional)			
Description	Provides externally accessible IS connections to the XNX transmitter to enable 'hot' connection of HC275/375 HART® or equivalent hand held configurator		
Installation	Fitted to one of the cable entries on the XNX transmitter. Option can be factory fitted or in the field by a qualified service engineer		
Environmental Protection	Port protected by cover to IP66/67 when not in use		
Relay Module (Optional)			
Description	Provides three fully user configurable relay outputs that can be switched based on the current gas level and/or status of the transmitter. Provides 2 x SPCO alarm and 1 x SPCO fault relay. Mutually exclusive with Modbus and/or Foundation Fieldbus™ options		
Rating	Maximum: 240VAC, 5A (non inductive load) Minimum: 5V, 10mA (non inductive load)		
Installation	Option can be factory installed in display module or in the field by a qualified service engineer		

Technical Summary

Foundation Fieldbus™ Module (Optional)

Description	Foundation Fieldbus™ output for connection to a multi-drop H1 network. Mutually exclusive with relays and/or Modbus options		
Installation	Option can be factory installed in display module or in the field by a qualified service engineer		
Connections	Sig+, Sig- and Screen		
Physical Layer	Conforms to IEC 1158-2 and ISA 50.02, 31.25Kbits/s		
Maximum No. of Nodes	32		
Functions Supported	Gas reading Gas name and units of measurement Instrument status (OK, warning, fault, over-range) General/Device Information Remote zero and span calibration (detector dependent)	Detailed sensor information Including: Optical Signal Level Dynamic reserve (Searchline Excel only) Raw reading 24V supply voltage Temperature Calibration and configuration status	Detailed Fault and Warning Information: Fault and alarm history Zero calibration

Modbus RTU Module (Optional)

Description	The Modbus output module provides an isolated RS485 output to enable the connection of the XNX transmitter to a multi-drop Modbus network. Mutually exclusive with relays and/or Foundation Fieldbus™ options
Installation	Option factory installed in display module or in the field by a qualified service engineer
Connections	RS485+, RS485-, Drain
Physical Layer	Isolated RS485, 1200 to 19.2K baud
Maximum No. of Nodes	254 XNX compatible transmitters only
Protocol	Modbus RTU
Functions Supported	As per Foundation Fieldbus™ Module (Optional) - see above

XNX EC Sensor

Gas	Cartridge P/N	Selectable Full Scale Range	Default Range	Lower Detectable Limit	Steps	Selectable Cal Gas Range	Default Cal Point	Response Time (T50) sec	Response Time (T90) sec	Accuracy*	Operating Temperature		
											Min	Max	
O ₂	Oxygen	XNXXS01SS	n/a	25.0 %Vol	3.5 %Vol	n/a	20.9 %Vol (Fixed)	20.9 %Vol	T20 <10	<30	<+/-0.6 %Vol	-30°C / -34°F	55°C / 131°F
H ₂ S (LoLo)	Hydrogen Sulphide	XNXXSH3SS	n/a	15.0ppm	1.0ppm	n/a	30 to 70% of selected full scale range	10ppm	<20	<40	<+/-0.3ppm	-40°C / -40°F	55°C / 131°F**
H ₂ S (Lo)	Hydrogen Sulphide	XNXXSH1SS	10.0 to 50.0ppm	15.0ppm	1.0ppm	0.1ppm		10ppm	<20	<30	<+/-0.3ppm	-40°C / -40°F	55°C / 131°F**
H ₂ S (Hi)	Hydrogen Sulphide	XNXXSH2SS	50 to 500ppm	100ppm	1ppm	10ppm		50ppm	<20	<30	<+/-0.3ppm	-40°C / -40°F	55°C / 131°F**
CO	Carbon Monoxide	XNXXSC1SS	100 to 500ppm	300ppm	5ppm	100ppm		100ppm	<15	<30	<+/-2ppm	-40°C / -40°F	55°C / 131°F**
SO ₂ (Lo)	Sulphur Dioxide	XNXXSS1SS	5.0 to 20.0ppm	15.0ppm	0.6ppm	5.0ppm		5.0ppm	<15	<30	<+/-0.3ppm	-40°C / -40°F	55°C / 131°F**
SO ₂ (Hi)	Sulphur Dioxide	XNXXSS2SS	20.0 to 50.0ppm	50.0ppm	1.5ppm	10.0ppm		25ppm	<15	<30	<+/-0.6ppm	-40°C / -40°F	55°C / 131°F**
NH ₃ (Lo)	Ammonia	XNXXSA1SS	50 to 200ppm	200ppm	6ppm	50ppm		100ppm	<60	<180	<+/-4ppm	-20°C / -4°F	40°C / 104°F
NH ₃ (Hi)	Ammonia	XNXXSA2SS	200 to 1,000ppm	1,000ppm	30ppm	50ppm		300ppm	<60	<180	<+/-20ppm	-20°C / -4°F	40°C / 104°F
CL ₂ (Lo)	Chlorine	XNXXSL2SS	n/a	5.00ppm	0.15ppm	n/a		2.0ppm	<20	<60	<+/-0.2ppm	-10°C / 14°F	55°C / 131°F
CL ₂ (Hi)	Chlorine	XNXXSL1SS	5.0 to 20.0ppm	5.0ppm	0.6ppm	5.0ppm		2.0ppm	<20	<30	<+/-0.2ppm	-10°C / 14°F	55°C / 131°F
ClO ₂	Chlorine Dioxide	XNXXSX1SS	n/a	1.00ppm	0.03ppm	n/a		0.5ppm	<30	<120	<+/-0.03ppm	-20°C / -4°F	55°C / 131°F
NO	Nitrogen Monoxide	XNXXSM1SS	n/a	100ppm	3ppm	n/a		50ppm	<15	<30	<+/-2ppm	-20°C / -4°F	55°C / 131°F
NO ₂	Nitrogen Dioxide	XNXXSN1SS	5.0 to 50.0ppm	10.0ppm	1.5ppm	5.0ppm		5ppm	<15	<30	<+/-0.2ppm	-20°C / -4°F	55°C / 131°F
H ₂ (Lo)	Hydrogen	XNXXSG1SS	n/a	1,000ppm	30ppm	n/a		500ppm	<60	<90**	<+/-8ppm	-20°C / -4°F	55°C / 131°F
H ₂ (Hi)	Hydrogen	XNXXSG2SS	n/a	10,000ppm	300ppm	n/a		5000ppm	<15	<30	<+/-150ppm	-20°C / -4°F	55°C / 131°F
HF	Hydrogen Fluoride	XNXXSF1SS	n/a	12.0ppm	0.4ppm	n/a		5.0ppm	120	<240	<+/-0.5ppm	-20°C / -4°F	55°C / 131°F
PH ₃	Phosphine	XNXXSP1SS	n/a	1.20 ppm	0.04ppm	n/a		0.5ppm	<15	<30	<+/- 0.02ppm	-20°C / -4°F	40°C / 104°F
HCN	Hydrogen Cyanide	XNXXSY1SS	n/a	30.0ppm	1.0ppm	n/a		10.0ppm	<35	<200	0.4ppm	-20°C / -4°F	55°C / 131°F
F ₂	Fluorine	XNXXSU1SS	n/a	4.00ppm	0.36ppm	n/a		2.00ppm	<5	<30	0.03ppm	-20°C / -4°F	55°C / 131°F
O ₃	Ozone	XNXXSZ1SS	n/a	0.400ppm	0.032ppm	n/a		0.200ppm	<15	<60	0.003ppm	-20°C / -4°F	55°C / 131°F
ETO	Ethylene Oxide	XNXXSE1SS	20.0 to 50.0ppm	25.0ppm	1.0ppm	5.0ppm	10.0ppm	<40	<125	0.3ppm	-20°C / -4°F	55°C / 131°F	

XNX Multi Purpose Detector (MPD)

Sensor Type	Target Gas	User Selectable Full Scale Range	Default Range	Steps	User Selectable Cal Gas Range	Primary Cal Gas	Default Cal Point	Response Time (T90) secs	Accuracy	Operating Temperature	
										Min	Max
IR CO2	Carbon Dioxide	1.00 to 5.00%Vol	5.00%Vol	1.00%Vol	1.50 to 3.5%Vol	Carbon Dioxide	2.5%Vol	<60	±5% of FS	-20°C/-4°F	+50°C/+122°F
IR CH4	Methane	1.00 to 5.00%Vol	5.00%Vol	1.00%Vol	1.50 to 3.5%Vol	Methane	2.5%Vol	<30	±5% of FS	-20°C/-4°F	+50°C/+122°F
		20 to 100%LEL	100%LEL	10%LEL	30 to 70%LEL		50%LEL		±5% of FS		
IR HC	Hydrocarbons [§]	20 to 100%LEL	100%LEL	10%LEL	30 to 70%LEL	Propane	50%LEL	<30	±5% of FS	-20°C/-4°F	+50°C/+122°F
Catalytic	Flammables	20 to 100%LEL	100%LEL	10%LEL	30 to 70%LEL	Methane	50%LEL	<30	±5% of FS	-40°C/-40°F	+65°C/+149°F

NOTES

Data taken at ambient conditions of 20°C, 50% RH. Data represents typical values of freshly calibrated sensors without optional accessories attached. *Accuracy at 10% of default full scale (typical A1 alarm) of applied gas, or minimum (whichever is greater). Measured using calibration flow housing at calibration flow rate. Performance figures are applicable between 10 and 90% of full scale. Performance figures are measured by test units calibrated at 50% of full scale. Contact Honeywell Analytics for any additional data or details. **Accuracy for operation between -20°C and -40°C is +/-30% of applied. Operation at these temperatures continuously (exceeding 12 hours) may cause deterioration in sensor performance and shorten sensor life.

[§]Propane sensor with linear cross reference for Ethylene, n Butane and n Pentane.

Contact Honeywell Analytics for any additional data or details.

Ordering Information

Ordering Information

Standard Supply: The XNX universal transmitter is supplied complete with integral wall mounting lugs, 5 x M25 cable entries (ATEX/IECEx) or 5 x 3/4" NPT conduit entries (UL/CSA), Magnetic wand/screwdriver, Allen key, 3 x blanking plugs, quick start guide and manual CD. MPD or XNX EC sensors and cartridges are supplied fitted to the bottom entry if ordered. Other sensors are supplied separately. Default settings are configured according to specified personality type (mV, EC or IR) and selected output options.

XNX-

Approval	Entry Type	Material	Personality	-	Option	Local HART	Sensor and Range
A ATEX/IEC	M M25	A Aluminium	Ec Interface for Electro-chemical Cartridges (Includes IS Barrier and Adaptor) For use with XNX Toxic and Oxygen Sensors	-	N No Option installed	N No Option installed	Specifies the MPD sensor
U UL- CSA	T ¾"NPT	S 316 Stainless Steel	Ir Interface for infrared Products Use with Searchline Excel, Searchpoint Optima and Generic 4-20mA inputs		R Relay Option	H Local Hart	NNN None
			mV Interface for milli-Volt sensors For use with MPD, Sensepoint (and Model 705) HT and PPM Sensors		M Modbus Option		CB1 Catalytic Bead
					F Foundation Fieldbus™ Option		IF1 IR Hydrocarbons (0-100%LEL Propane)
							IV1 IR 0-100%LEL (or 0-5%Vol.) Methane
							IC1 IR Carbon Dioxide 0-5%Vol.





Example part number:
XNX-AMSV-NNCB1
 XNX transmitter with HART® over 4-20mA output
 ATEX/IEC approved
 5 x M25 entries
 painted 316 stainless steel
 mV version
 no output options
 no local HART
 Including MPD sensor: catalytic sensor 0-100%LEL.

NOTES
 Certain combinations not available e.g. ATEX with ¾" NPT entries. Check price list for valid configurations.
 Order sensors other than MPD separately and select 'NNN' for sensor and range.

Shipping Details

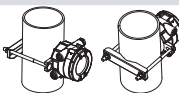
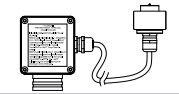
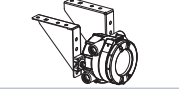
Shipping Carton	L370mm (14.6") x W280mm (11") x D180mm (7.1").
Packed weight (Approx.)	Aluminium version 4.4kg (9.7lbs), stainless steel version 6.8kg (15lbs)

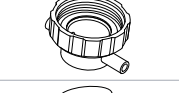
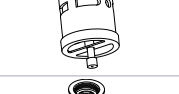
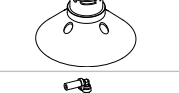
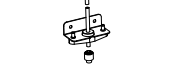
Optional Accessories

	Pipe Mount Kit	1226A0358	For use on pipes from 50-100mm (2-6 inches) in diameter. The kit includes: Pipe mount bracket, (2) carriage bolts, nuts and lock washers.
	Remote EC Sensor Mounting Kit	S3KRMK	The remote sensor mounting kit (S3KRMK) allows the XNX EC sensors to be remotely mounted via an IS cable kit, up to 15 meters (50 feet) from the transmitter. The kit includes 15 meters of shielded cable, cable glands and remote terminal box. The cable can be cut to the required length and terminated at the remote terminal box.
	Ceiling Mount Bracket Kit	1226A0355	The optional ceiling mount bracket kit allows XNX to be mounted to a ceiling. The kit includes: (2) stainless steel ceiling mount brackets, bolts and nuts.
	Duct Mount Kit	S3KDMK	The duct mounting kit (S3KDMK) can be used with the EC sensor to allow detection of flammable O ₂ , CO, H ₂ and H ₂ S gasses in ducts. When combined with the MPD interface adapter (1226A0382), the duct mounting kit can accommodate the MPD to detect flammable gases in a duct application. The duct mount kit includes the adapter, gasket and required fasteners. The MPD interface adapter includes only the adapter and requires the S3KDMK duct mount kit.
	MPD Interface Adapter	1226A0382	
	Calibration Gas Flow Adapter	S3KCAL 1226A0411 02000-A-1645 00780-A-0035	The calibration gas flow adapter is used to apply calibration test gas to the sensor. It push fills onto the bottom of the sensor and can be fitted without removing the weatherproof cover.
	Weatherproof Cap	Included 02000-A-1640 02000-A-1640 00780-A-2076	
	Collecting Cone	SPPPCC 02000-A-1642 02000-A-1642 02000-A-1642	The collecting cone improves detection of lighter-than-air gasses such as Hydrogen and Methane.
	Remote Gassing Kit	1226A0354	

Honeywell Analytics Gas Detection

Honeywell Analytics is able to provide gas detection solutions to meet the requirements of all applications and industries. Contact us in the following ways:

Headquarters

Europe, Middle East, Africa

Life Safety Distribution AG
Javastrasse 2
8604 Hegnau
Switzerland
Tel: +41 (0)44 943 4300
Fax: +41 (0)44 943 4398
gasdetection@honeywell.com

Customer Service:

Tel: 00800 333 222 44 (Freephone number)
Tel: +41 44 943 4380 (Alternative number)
Fax: 00800 333 222 55
Middle East Tel: +971 4 450 5800 (Fixed Gas Detection)
Middle East Tel: +971 4 450 5852 (Portable Gas Detection)

Americas

Honeywell Analytics Distribution Inc.
405 Barclay Blvd.
Lincolnshire, IL 60069
USA
Tel: +1 847 955 8200
Toll free: +1 800 538 0363
Fax: +1 847 955 8210
detectgas@honeywell.com

Asia Pacific

Honeywell Analytics
Asia Pacific
#701 Kolon Science Valley (1)
43 Digital-Ro 34-Gil, Guro-Gu
Seoul 152-729
Korea
Tel: +82 (0) 2 6909 0300
Fax: +82 (0) 2 2025 0328
India Tel: +91 124 4752700
analytics.ap@honeywell.com

Technical Support Centres

Honeywell Analytics Ltd.
4 Stinsford Road
Nuffield Industrial Estate
Poole, Dorset, BH17 0RZ
United Kingdom
Tel: +44 (0) 1202 645 544
Fax: +44 (0) 1202 645 555

Honeywell Analytics
ZAC Athélia 4 - 375 avenue du Mistral
Bât B, Espace Mistral
13600 La Ciotat
France
Tel: +33 (0) 4 42 98 17 75
Fax: +33 (0) 4 42 71 97 05

Honeywell Analytics
Elsenheimerstrasse 43
80687 München
Germany
Tel: +49 89 791 92 20
Fax: +49 89 791 92 43

Honeywell Analytics
P.O. Box-45595
6th Street
Musaffah Industrial Area
Abu Dhabi
UAE
Tel: +971 2 554 6672
Fax: +971 2 554 6672

EMEA: HAexpert@honeywell.com
US: ha.us.service@honeywell.com
AP: ha.ap.service@honeywell.com

www.honeywellanalytics.com
www.raesystems.com

Honeywell Analytics
Experts in Gas Detection

Please Note:

While every effort has been made to ensure accuracy in this publication, no responsibility can be accepted for errors or omissions. Data may change, as well as legislation, and you are strongly advised to obtain copies of the most recently issued regulations, standards, and guidelines. This publication is not intended to form the basis of a contract.

12550_H_XNX_DS01078_V5_EMEA

09/15

© 2015 Honeywell Analytics



Honeywell

AUTHORIZED DISTRIBUTOR

De Gidts & Feldman BV
The Netherlands
www.dgfg.nl



De Gidts & Feldman

INSTRUMENTATION & FILTRATION